



NuTiny-SDK-NUC131SD2AE User Manual

The information described in this document is the exclusive intellectual property of Nuvoton Technology Corporation and shall not be reproduced without permission from Nuvoton.

Nuvoton is providing this document only for reference purposes of NuMicro™ microcontroller based system design. Nuvoton assumes no responsibility for errors or omissions.

All data and specifications are subject to change without notice.

For additional information or questions, please contact: Nuvoton Technology Corporation.



Table of Contents

1	Overview	3
2	Introduction to NuTiny-SDK- NUC131SD2AE	4
1.	NuTiny-SDK- NUC131SD2AE Jumper Description	5
2.	Pin Assignment for Extended Connectors	6
3.	NuTiny-SDK- NUC131SD2AE PCB Placement	8
3	Starting to Use NuTiny-SDK- NUC131SD2AE on the Keil μ Vision [®] IDE	9
4.	Downloading and Installing Keil μ Vision [®] IDE Software	9
5.	Downloading and Installing Nuvoton Nu-Link Driver	9
6.	Hardware Setup.....	9
7.	Example Program.....	10
4	Starting to Use NuTiny-SDK- NUC131SD2AE on the IAR Embedded Workbench	11
8.	Downloading and Installing IAR Embedded Workbench Software.....	11
9.	Downloading and Installing Nuvoton Nu-Link Driver	11
10.	Hardware Setup.....	11
11.	Example Program.....	12
5	NuTiny-SDK- NUC131SD2AE Schematics	13
12.	NuTiny-EVB- NUC131SD2AE Schematic	13
13.	NuTiny-EVB- NUC131SD2AE Schematic	14
14.	Nu-Link-Me Schematic.....	15
6	Downloading NuMicro [™] Related Files from Nuvoton Website	16
15.	Downloading NuMicro [™] Keil μ Vision [®] IDE Driver	16
16.	Downloading NuMicro [™] IAR EWARM Driver	18
17.	Downloading NuMicro [™] NUC131SD2AE Series BSP Software Library	20
7	Revision History	22



1 Overview

The NuTiny-SDK- NUC131SD2AE is a specific development tool for NuMicro™ M0518 series by which users can develop and verify the application program easily. The NuTiny-SDK-NUC131SD2AE includes two portions: NuTiny-EVB-NUC131SD2AE (an evaluation board) and Nu-Link-Me (Debug Adaptor). With the NuTiny-SDK-NUC131SD2AE, users do not need additional ICE or debug equipment.

2 Introduction to NuTiny-SDK- NUC131SD2AE

The following figure shows the NuTiny-SDK- NUC131SD2AE for NUC131SD2AE series, in which the left portion is called NuTiny-EVB- NUC131SD2AE and the right portion is Debug Adaptor called Nu-Link-Me.

The NuTiny-EVB- NUC131SD2AE is similar to other development board. Users can use it to develop and verify applications to emulate the real behavior. In fact, the real chip NUC131SD2AE is mounted on the board. The NuTiny-EVB- NUC131SD2AE can be a real system controller to design user target system.

The Nu-Link-Me is a Debug Adaptor which connects the USB port of your PC to your target system (via Serial Wired Debug Port) and allows you to program and debug embedded programs on the target hardware. To use the Nu-Link-Me Debug adaptor with Keil or IAR, please refer to “Nuvoton NuMicro™ IAR ICE Driver User Manual” or Nuvoton NuMicro™ Keil ICE Driver User Manual” for details.

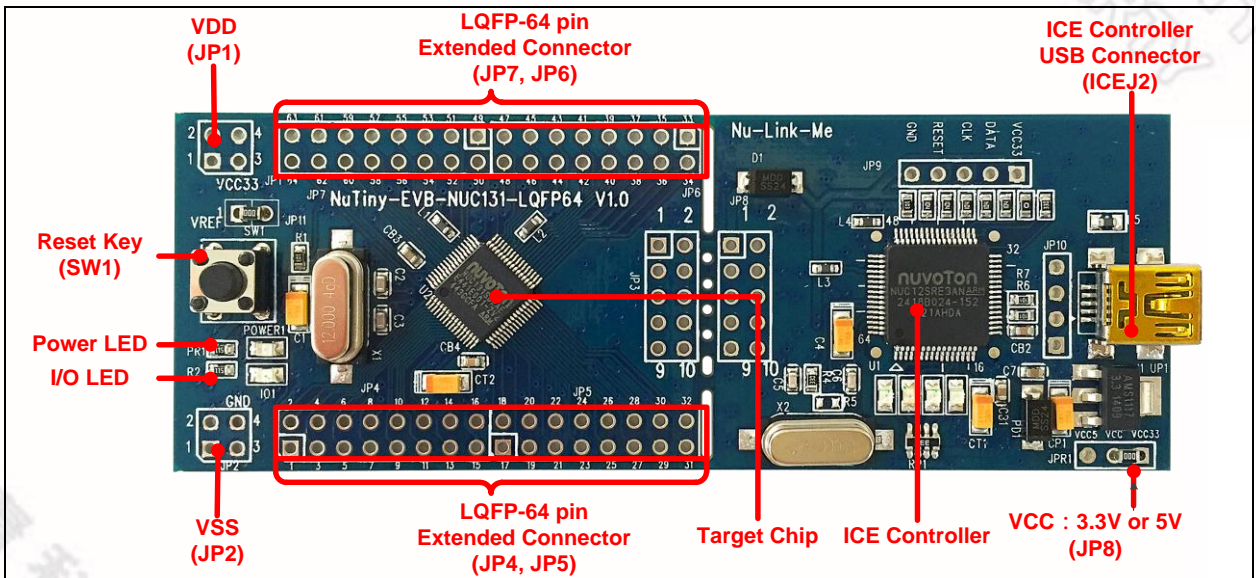

Figure 2-1 NuTiny-SDK- NUC131SD2AE (Green PCB Board)

1. NuTiny-SDK- NUC131SD2AE Jumper Description

2.1.1 Power Settings

- **JP1**: VDD Voltage connector in NuTiny-EVB- NUC131SD2AE
- **J1**: USB port in Nu-Link-Me

Model	JPR1	J1 USB port	JP1 VDD	MCU Voltage
Model 1	Select VCC33 (default)	Connect to PC	DC 3.3V output	DC 3.3V
Model 2	X	X	DC 2.5 V ~ 5.5 V Input	Voltage by JP1 input

X: Unused.

2.1.2 Debug Connectors

- **JP3**: Connector in target board (NuTiny-EVB- NUC131SD2AE) for connecting with Nuvoton ICE adaptor (Nu-Link-Me)
- **JP8**: Connector in ICE adaptor (Nu-Link-Me) for connecting with a target board (e.g. NuTiny-EVB- NUC131SD2AE)

2.1.3 USB Connectors

- **J1**: Mini USB Connector in Nu-Link-Me connected to a PC USB port

2.1.4 Extended Connectors

- **JP4, JP5, JP6 and JP7**: Show all chip pins in NuTiny-EVB- NUC131SD2AE

2.1.5 Buttons

- **SW1**: Reset button in NuTiny-EVB- NUC131SD2AE

2.1.6 Power Connectors

- **JP1**: VDD connector in NuTiny-EVB- NUC131SD2AE
- **JP2**: VSS connector in NuTiny-EVB- NUC131SD2AE



2. Pin Assignment for Extended Connectors

The NuTiny-EVB- NUC131SD2AE provides the NUC131SD2AE target chip on board and the extended connectors (**JP4**, **JP5**, **JP6** and **JP7**) for LQFP48-pin. The following table is the pin assignment for NUC131SD2AE.

Pin No	Pin Name	Pin No	Pin Name
01	PB.14,INT0	33	PC.11,PWM1_BRAKE1
02	PB.13	34	PC.10,PWM1_BRAKE0
03	PB.12,CLKO,BPWM1_CH3	35	PC.9,PWM0_BRAKE1
04	PF.5,I2C0_SCL,PWM1_CH5	36	PC.8,PWM0_BRAKE0
05	PF.4,I2C0_SDA,PWM1_CH4	37	PA.15,PWM0_CH3
06	PA.11,I2C1_SCL,PWM1_CH3	38	PA.14,PWM0_CH2
07	PA.10,I2C1_SDA,PWM1_CH2	39	PA.13,PWM0_CH1,UART5_TXD
08	PA.9,I2C0_SCL,UART1_nCTS	40	PA.12,PWM0_CH0,UART5_RXD
09	PA.8,I2C0_SDA,UART1_nRTS	41	PF.7,ICE_DAT
10	PB.4,UART1_RXD	42	PF.6,ICE_CLK
11	PB.5,UART1_TXD	43	AVSS
12	PB.6,UART1_nRTS	44	PA.0,PWM0_CH4,ADC0,I2C1_SCL,UART5_TXD
13	PB.7,UART1_nCTS	45	PA.1,PWM0_CH5,ADC1,I2C1_SDA,UART5_RXD
14	LDO_CAP	46	PA.2,PWM1_CH0,ADC2,UART3_TXD
15	VDD	47	PA.3,PWM1_CH1,ADC3,UART3_RXD
16	VSS	48	PA.4,ADC4
17	PB.0,UART0_RXD	49	PA.5,UART3_RXD,ADC5
18	PB.1,UART0_TXD	50	PA.6,UART3_TXD,ADC6
19	PB.2,UART0_nRTS,TM2_EXT,TM2,PWM1_BRAKE1	51	PA.7,Vref,ADC7
20	PB.3,UART0_nCTS,TM3_EXT,TM3,PWM1_BRAKE0	52	AVDD
21	PD.6,BPWM1_CH1,CAN0	53	PC.7,PWM0_BRAKE1,I2C0_S



	_RXD		CL,UART4_RXD
22	PD.7,BPWM1_CH0,CAN0_TXD	54	PC.6,PWM0_BRAKE0,I2C0_SDA,UART4_TXD
23	PD.14,BPWM0_CH5,UART2_RXD	55	PC.15
24	PD.15,BPWM0_CH4,UART2_TXD	56	PC.14
25	PC.3,BPWM0_CH3,SPI0_MOSI0	57	PB.15, ,BPWM1_CH5TM0, TM0_EXT,INT1
26	PC.2,BPWM0_CH2,SPI0_MISO0	58	PF.0,XT1_OUT
27	PC.1,BPWM0_CH1,SPI0_CLK	59	PF.1,XT1_IN
28	PC.0,BPWM0_CH0,SPI0_SS0	60	nRESET
29	PE.5,PWM0_CH5, TM1_EXT, TM1	61	VSS
30	PB.11, TM3, PWM0_CH4	62	VDD
31	PB.10, TM2	63	PF.8, PWM1_CH4, CLKO
32	PB.9, TM1	64	PB.8,BPWM1_CH2,CLKO, TM0,STADC

Table 2-1 Pin Assignment for NUC131SD2AE

3. NuTiny-SDK- NUC131SD2AE PCB Placement

The following figure shows the NuTiny-SDK- NUC131SD2AE PCB placement.

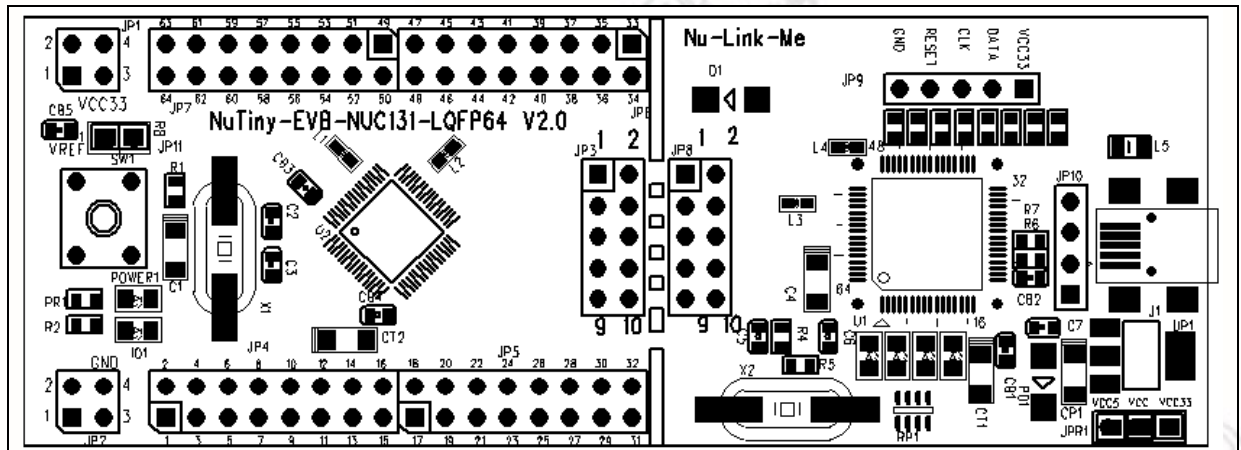

Figure 2-2 NuTiny-SDK- NUC131SD2AE PCB Placement

3 Starting to Use NuTiny-SDK- NUC131SD2AE on the Keil μ Vision[®] IDE

4. Downloading and Installing Keil μ Vision[®] IDE Software

Please connect to the Keil company website (<http://www.keil.com>) to download the Keil μ Vision[®] IDE and install the RVMDK.

5. Downloading and Installing Nuvoton Nu-Link Driver

Please connect to Nuvoton NuMicro[™] website (<http://www.nuvoton.com/NuMicro>) to download the “NuMicro[™] Keil μ Vision[®] IDE driver” file. Please refer to *section 15* for the detailed download flow. After the Nu-Link driver is downloaded, please unzip the file and execute the “Nu-Link_Keil_Driver.exe” to install the driver.

6. Hardware Setup

The hardware setup is shown in the following figure.



Figure 3-1 NuTiny-SDK- NUC131SD2AE Hardware Setup

7. Example Program

This example demonstrates how to download and debug an application on a NuTiny-SDK- NUC131SD2AE board.

The example file can be found in the directory list shown in the following figure.

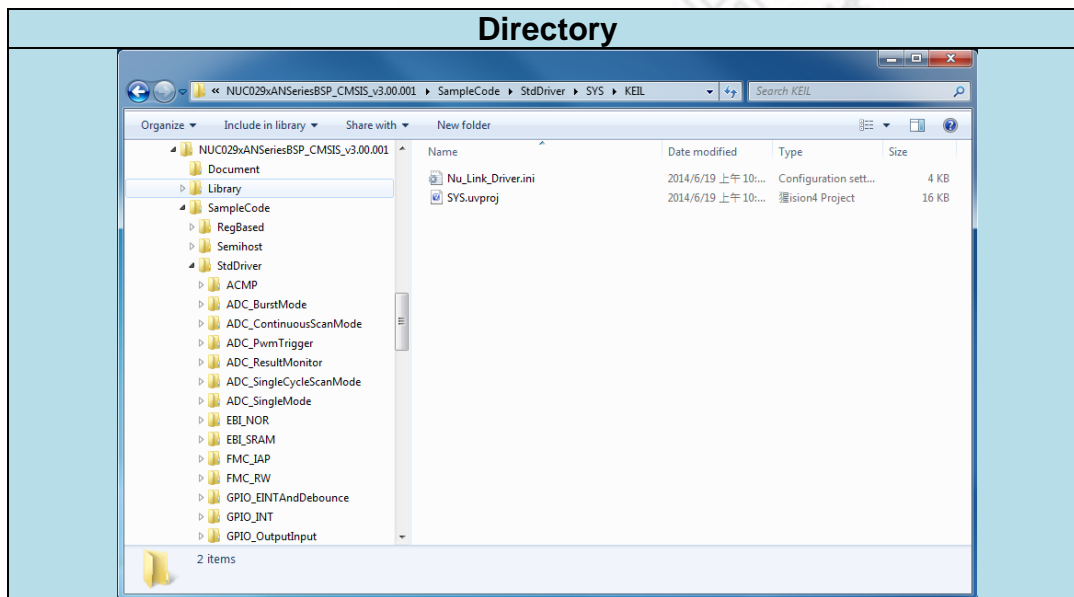

Figure 3-2 Example Directory

To use this example:

The I/O LED on the NuTiny-EVB- NUC131SD2AE board will turn on.

- **Start µVision®**
- **Project – Open**
Open the SYS.uvproj project file
- **Project – Build**
Compile and link the SYS application
- **Flash – Download**
Program the application code into on-chip Flash ROM
- **Start Debug mode**
When using the debugger commands, you may:
 - ◆ Review variables in the watch window
 - ◆ Single step through code
 - ◆ Reset the device
 - ◆ Run the application

4 Starting to Use NuTiny-SDK- NUC131SD2AE on the IAR Embedded Workbench

8. Downloading and Installing IAR Embedded Workbench Software

Please connect to IAR company website (<http://www.iar.com>) to download the IAR Embedded Workbench and install the EWARM.

9. Downloading and Installing Nuvoton Nu-Link Driver

Please connect to Nuvoton Company NuMicro™ website (<http://www.nuvoton.com/NuMicro>) to download “NuMicro™ IAR EWARM Driver” file. Please refer to *section 16* for the detail download flow. After the Nu-Link driver is downloaded, please unzip the file and execute the “Nu-Link_IAR_Driver.exe” to install the driver.

10. Hardware Setup

The hardware setup is shown in the following figure.



Figure 4-1 NuTiny-SDK- NUC131SD2AE Hardware Setup

11. Example Program

This example demonstrates how to download and debug an application on a NuTiny-SDK- NUC131SD2AE board.

The example file can be found in the directory list shown in the following figure.

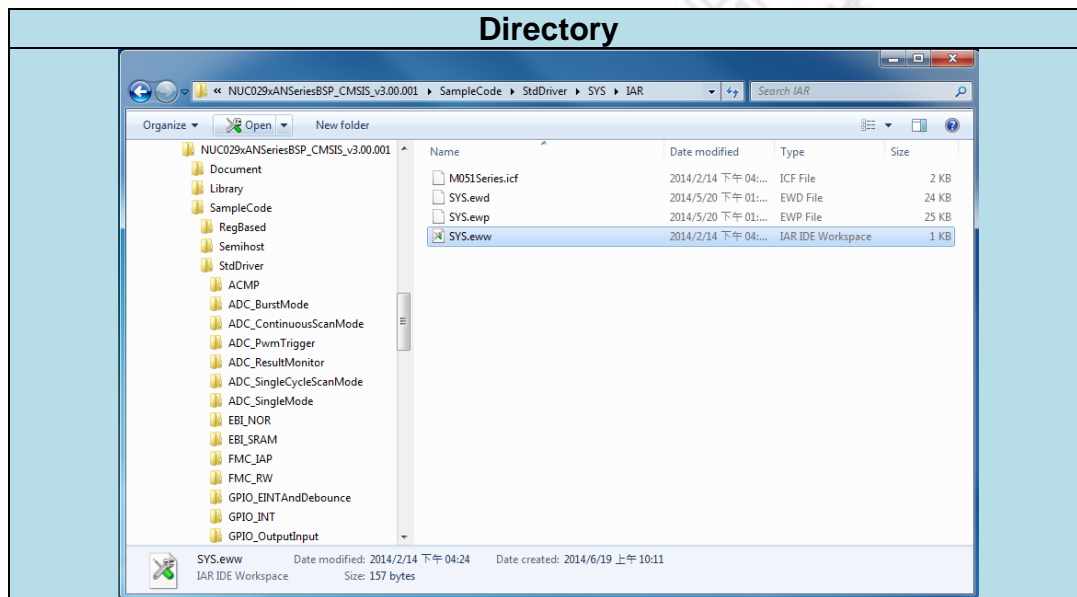

Figure 4-2 Example Directory

To use this example:

The I/O LED on the NuTiny-EVB- NUC131SD2AE board will turn on.

- **Start IAR Embedded Workbench**
- **File-Open-Workspace**
Open the SYS.eww workspace file
- **Project - Make**
Compile and link the SYS application
- **Project – Download and Debug**
Program the application code into on-chip Flash ROM
 - ◆ Single step through code
 - ◆ Reset the device
 - ◆ Run the application

5 NuTiny-SDK- NUC131SD2AE Schematics

12. NuTiny-EVB- NUC131SD2AE Schematic

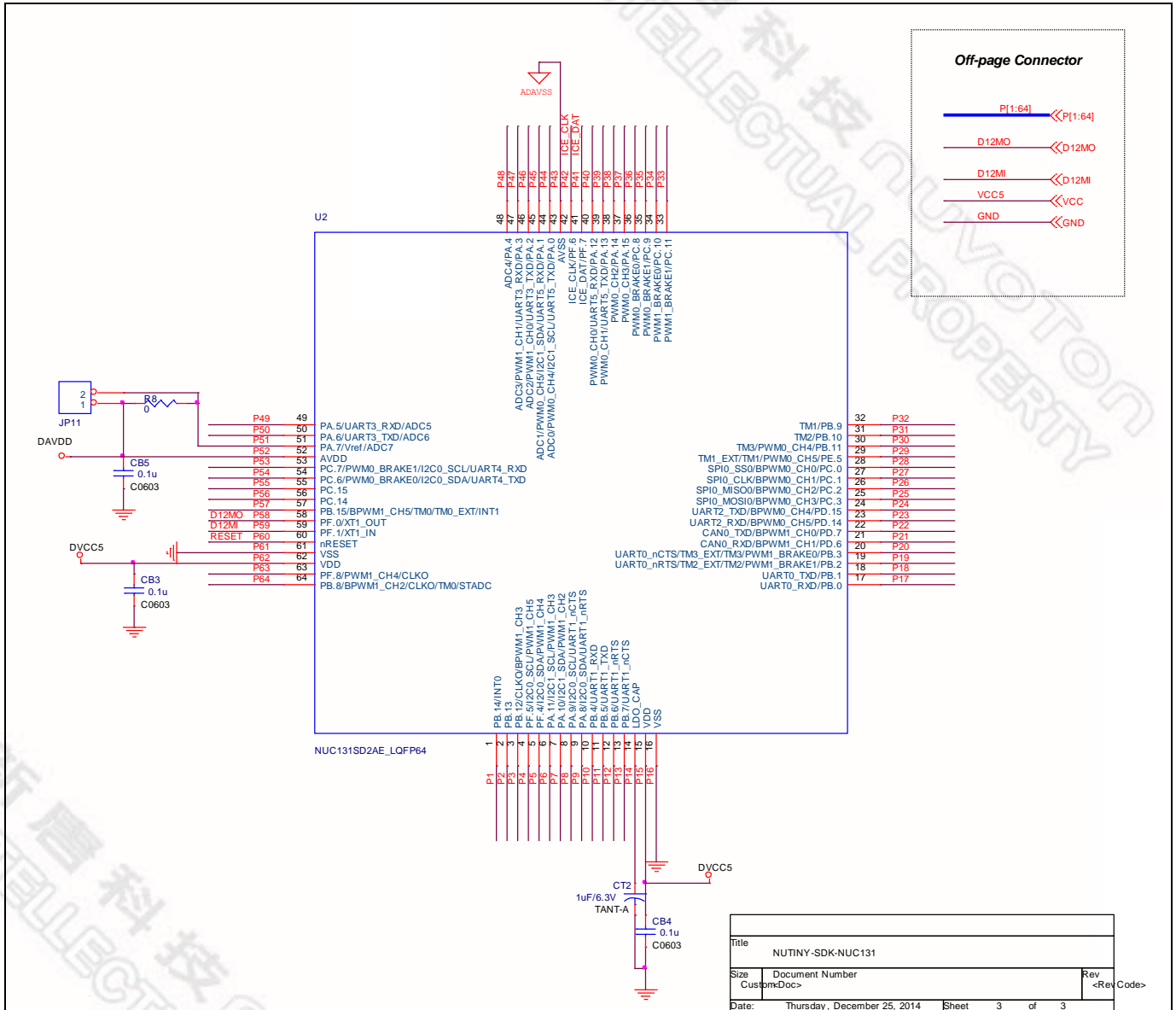

13. NuTiny-EVB- NUC131SD2AE Schematic

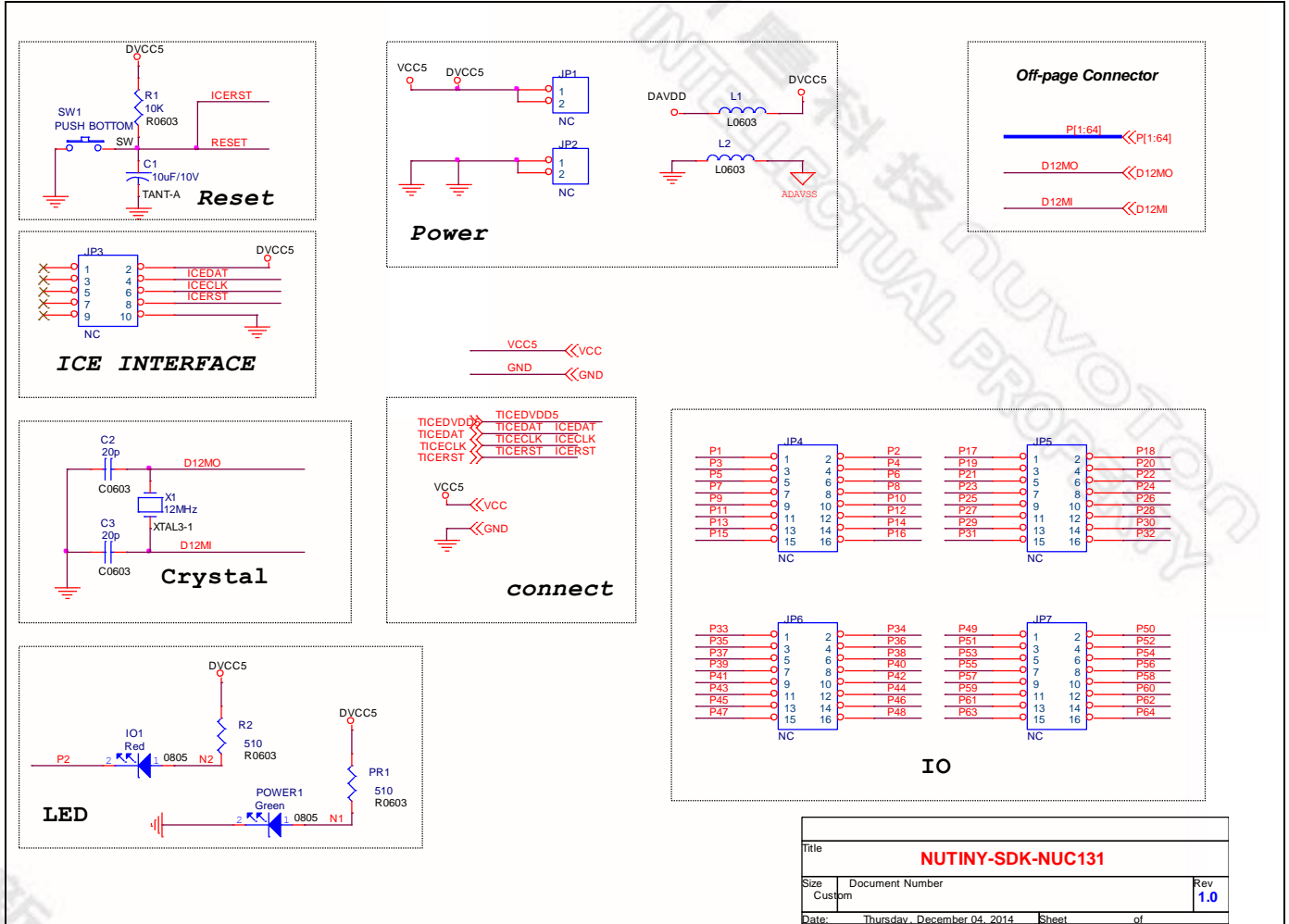

14. Nu-Link-Me Schematic

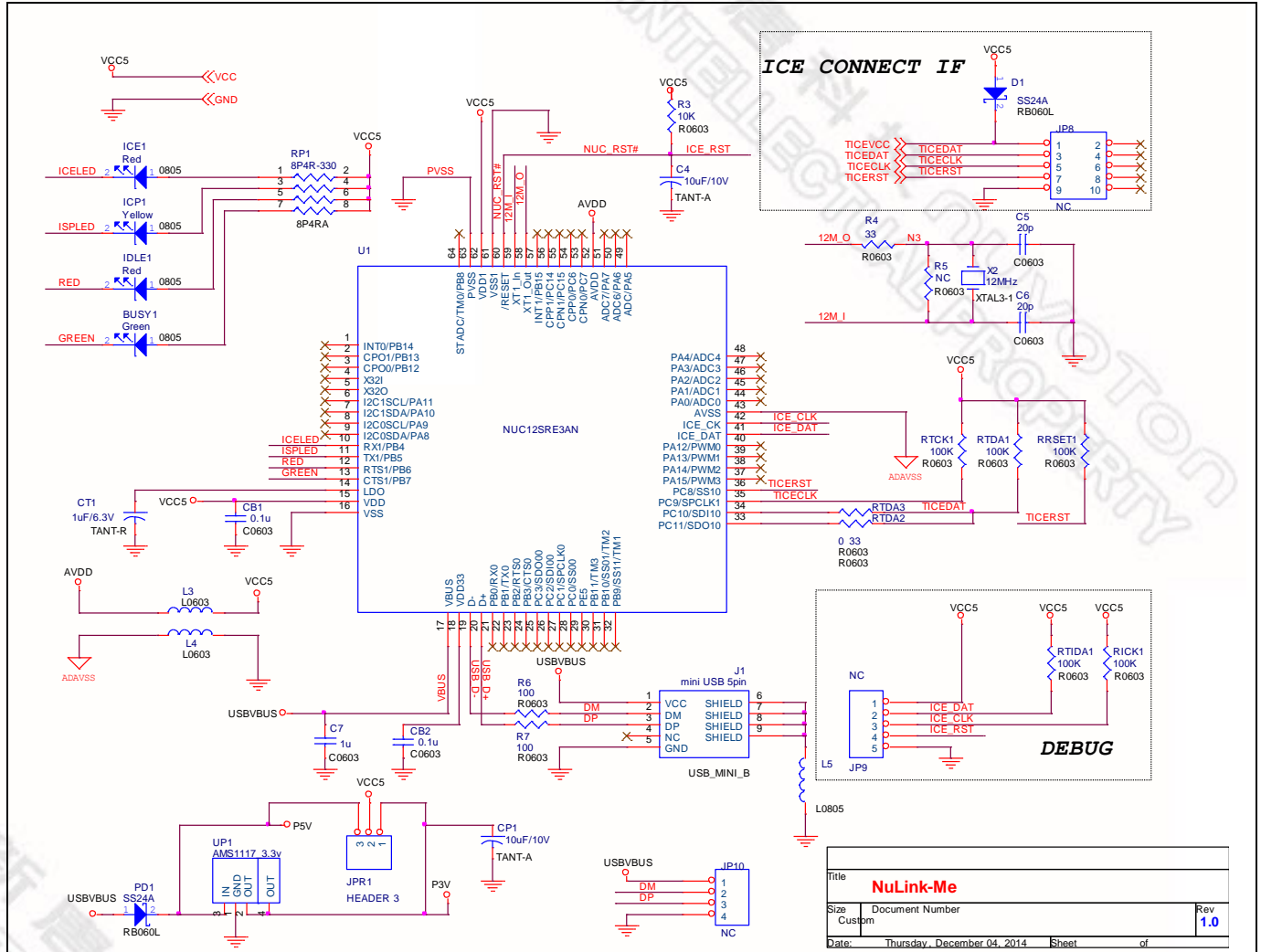



6 Downloading NuMicro™ Related Files from Nuvoton Website

15. Downloading NuMicro™ Keil µVision® IDE Driver

Step1	Visit the Nuvoton NuMicro™ website: http://www.nuvoton.com/NuMicro .
Step2	<p>The screenshot shows the Nuvoton website interface. A yellow oval labeled '2-1. Move to "Support"' points to the 'Support' link in the top navigation bar. A red dashed box highlights the 'Support' dropdown menu, which includes 'Learning', 'Product Related Information', 'Tool & Software', 'Reference Design', 'FAQ', 'Sales Support', 'Technical Support', and 'Forum'. A second yellow oval labeled '2-2. Click here to enter Tool & Software' points to the 'Tool & Software' option in the dropdown menu. The main content area displays a grid of product series categorized by application (Industrial Control, Low Power, USB Application, Automotive Application, Audio Application) and memory size (16K, 32K, 64K, 128K, 256K). A 'Featured Products' section on the right lists M0516LDE, MINI54FDE, and NANO130KE3BN. A 'Featured Videos' section includes 'M0 Introduction(06:35)'. A 'Featured Applications' section is also visible at the bottom.</p>

Register | Login
Language ▼

Parametric Search

News | Events | CSR | Human Resources | Investors | Contact Us | NuvoTon Partner

Products
Applications
Support
Foundry Service
Buy
myNuvoTon
About NuvoTon

Home > Support > Tool & Software > Development Tool Hardware

Development Tool Hardware

Learning

Product Related Information

Tool & Software

Development Tool Hardware

Development Kit

Learning Board

Programmer

Software

Third Party Tool

Reference Design

FAQ

Sales Support

Technical Support

Forum

Development

Evaluation Board

Customer Target Board

NuTiny Board

Mass Production

On-Line In Circuit Programming

Off-Line In Circuit Programming

IC Programming

Upgrade

In System Programming

Through -UART -USB -I2C -SPI -CAN -I/O

Events

Nuovon Technology Hosts 32-bit Cortex™-M4 Ether... 2014-05-02

2014Q1 Investor Conference 2014-04-24

News

Nuovon Announces Monthly Revenue for May 2014 2014-06-06

Programmer Software Tools Package

File name	Description	Version	Date
ICP Programming Tool V1.27.6340.zip Revision History	NuMicro ICP tool & user manual	V1.27.6340	2014-10-30
ISP Programming Tool V1.44.zip Revision History	NuMicro ISP Programming Tool & user manual	V1.44	2014-09-01
NuGang Programmer V6.23.zip Revision History	NuMicro NuGang Programmer user manual	V6.23	2014-12-17

Nu-Link Driver

File name	Description	Version	Date
Nu-Link Driver for Keil RVMDK V1.27.6340.zip Revision History	This driver is to support Nu-Link to work under Keil RVMDK Development Environment for all NuMicro Family Devices.	V1.27.6340	2014-10-30
Nu-Link Driver for IAR EWARM V1.27.6340.zip Revision History	This driver is to support Nu-Link to work under IAR EWARM Development Environment for all NuMicro Family Devices.	V1.27.6340	2014-10-30

Step5 Download the NuMicro™ Keil μVision® IDE driver.

Step3

Step4

Step5

Click here to enter Software download page

Click here to download the file.



16. Downloading NuMicro™ IAR EWARM Driver

Step1 Visit the Nuvoton NuMicro™ website: <http://www.nuvoton.com/NuMicro>.

Step2

The screenshot shows the Nuvoton NuMicro website interface. A yellow oval labeled '2-1. Move to "Support"' points to the 'Support' link in the top navigation bar. A red dashed box highlights the 'Support' dropdown menu, with a yellow oval labeled '2-2. Click here to enter Tool & Software' pointing to the 'Tool & Software' option. The main content area displays a product matrix for ARM Cortex-M0 MCUs, categorized by memory size (16K, 32K, 64K, 128K, 256K) and application type (Industrial Control, Low Power, USB Application, Automotive Application, Audio Application). Various product models like NUC100, Nano100, NUC120, NUC130, NUC122, NUC123, NUC220, NUC240, AU9110, and AU9120* are shown. The right sidebar includes sections for 'Online Support', 'Featured Products', 'Featured Videos', and 'Featured Applications'.

As one of the leading Microcontroller (MCU) companies in the world, Nuvoton provides the state-

Step3

Register | Login | Language

Search Parametric Search

News | Events | CSR | Human Resources | Investors | Contact Us | NuvoTon Partner

Products Applications Support Foundry Service Buy myNuvoTon About NuvoTon

Home > Support > Tool & Software > Development Tool Hardware

Development Tool Hardware

Learning
Product Related Information
Tool & Software
Development Tool Hardware
Development Kit
Learning Board
Programmer
Software
Third Party Tool
Reference Design
FAQ
Sales Support
Technical Support
Forum

Click here to enter Software download page

On-Line In Circuit Programming
Customer Target Board
Off-Line In Circuit Programming
Customer Target Board
IC Programming
NuvoTon ICP AP
nuvoTon ISP AP
nuvoTon ISP AP
Through -UART -USB -I2C -SPI -CAN -I/O
In System Programming
NuMicro M4 MCU NUC472 with Ethernet MAC

Events
NuvoTon Technology Hosts 32-bit Cortex™-M4 Ether... 2014-05-02
2014Q1 Investor Conference 2014-04-24
More...

News
NuvoTon Announces Monthly Revenue for May 2014 2014-06-06

Step4

Programmer Software Tools Package

File name	Description	Version	Date
ICP Programming Tool V1.27.6340.zip Revision History	NuMicro ICP tool & user manual	V1.27.6340	2014-10-30
ISP Programming Tool V1.44.zip Revision History	NuMicro ISP Programming Tool & user manual	V1.44	2014-09-01
NuGang Programmer V6.23.zip Revision History	NuGang Programmer software & user manual	V6.23	2014-12-17

Nu-Link Driver

File name	Description	Version	Date
Nu-Link Driver for Keil RVMDK V1.27.6340.zip Revision History	This driver is to support Nu-Link to work under Keil RVMDK Development Environment for all NuMicro Family Devices.	V1.27.6340	2014-10-30
Nu-Link Driver for IAR EWARM V1.27.6340.zip Revision History	This driver is to support Nu-Link to work under IAR EWARM Development Environment for all NuMicro Family Devices.	V1.27.6340	2014-10-30

Click here to download the file.

Step5

Download the NuMicro™ IAR EWARM driver.



17. Downloading NuMicro™ NUC131SD2AE Series BSP Software Library

Step1 Visit the Nuvoton NuMicro™ website: <http://www.nuvoton.com/NuMicro>.

Step2

The screenshot shows the Nuvoton NuMicro website interface. A yellow oval labeled '2-1. Move to "Support"' points to the 'Support' link in the top navigation bar. A red dashed box highlights the 'Support' dropdown menu, with a yellow oval labeled '2-2. Click here to enter Tool & Software' pointing to the 'Tool & Software' option. The main content area displays a product matrix for ARM Cortex-M0 MCUs, categorized by core size (16K, 32K, 64K, 128K, 256K) and application (Industrial Control, Low Power, USB Application, Automotive Application, Audio Application). Various product models like NUC100, Nano100, NUC120, NUC130, NUC122, NUC123, M051, Nano102, Nano112, NUC220, NUC240, AU9110, and AU9120* are shown. The right sidebar includes sections for 'Online Support', 'Featured Products', 'Featured Videos', and 'Featured Applications'.

As one of the leading Microcontroller (MCU) companies in the world, Nuvoton provides the state-

<p>Step3</p>	<p>The screenshot shows the NuvoTon website's 'Development Tool Hardware' page. The left sidebar contains a list of links: Learning, Product Related Information, Tool & Software, Development Tool Hardware, Development Kit, Learning Board, Programmer, Software (highlighted with a red dashed box and a yellow callout bubble), Third Party Tool, Reference Design, FAQ, Sales Support, Technical Support, and Forum. The main content area is divided into three columns: 'Development' (with links for Evaluation Board, Customer Target Board, and NuTiny Board), 'Mass Production' (with links for On-Line In Circuit Programming, Off-Line In Circuit Programming, and IC Programming), and 'Upgrade' (with links for In System Programming and Through). A yellow callout bubble with the text 'Click here to enter Software download page' points to the 'Software' link in the sidebar.</p>
<p>Step4</p>	<p>Download the NuMicro™ NUC131 Series CMSIS BSP.</p>

新唐科技 NUVOTON
INTELLECTUAL PROPERTY



7 Revision History

Revision	Date	Description
1.00	Des. 25, 2014	Preliminary version.

Important Notice

Nuvoton Products are neither intended nor warranted for usage in systems or equipment, any malfunction or failure of which may cause loss of human life, bodily injury or severe property damage. Such applications are deemed, "Insecure Usage".

Insecure usage includes, but is not limited to: equipment for surgical implementation, atomic energy control instruments, airplane or spaceship instruments, the control or operation of dynamic, brake or safety systems designed for vehicular use, traffic signal instruments, all types of safety devices, and other applications intended to support or sustain life.

All Insecure Usage shall be made at customer's risk, and in the event that third parties lay claims to Nuvoton as a result of customer's Insecure Usage, customer shall indemnify the damages and liabilities thus incurred by Nuvoton.

Please note that all data and specifications are subject to change without notice.
All the trademarks of products and companies mentioned in this datasheet belong to their respective owners.