

THIS IS A C.A.D. GENERATED DRAWING
DO NOT MAKE MANUAL REVISIONS TO MASTER.

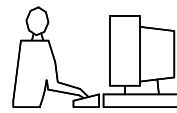

* UNLESS OTHERWISE SPECIFIED TOLERANCES
ON DECIMAL IS:
UNIT: INCH (MM)

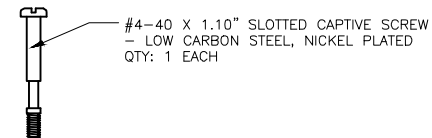
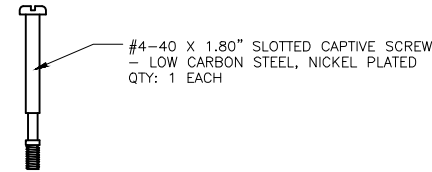
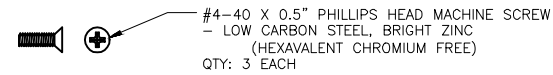
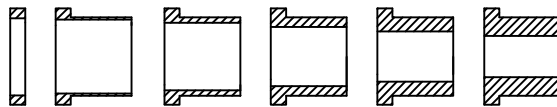
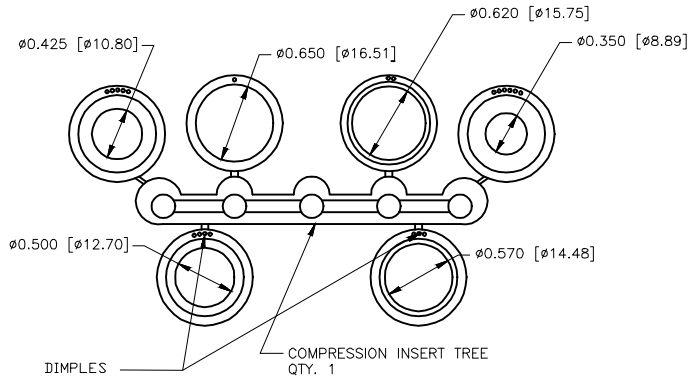
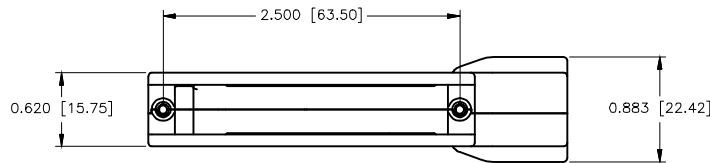
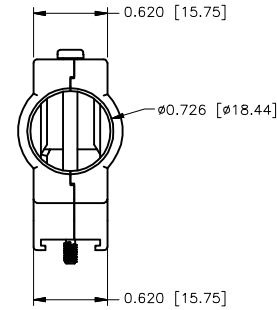
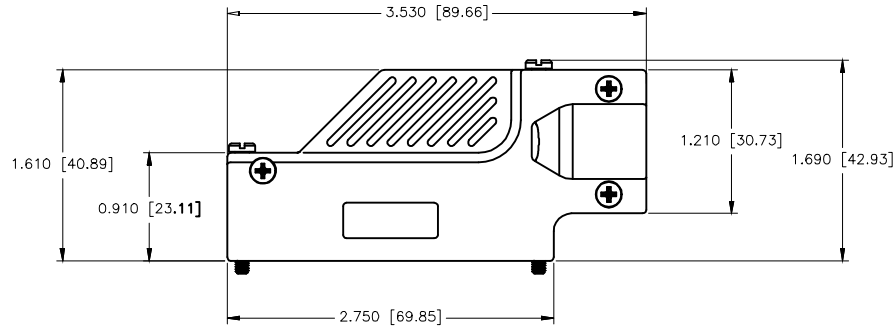

1. CONNECTOR COVER:

- 1.1 MATERIAL: ZINC ALLOY
- 1.2 FINISH: NICKEL PLATING
- 1.3 TOLERANCES: ±0.015 (0.381)

2. COMPRESSION INSERT TREE:

- 2.1 MATERIAL: THERMOPLASTIC
- 2.2 COLOR: BLACK
- 2.3 DUROMETER: 75±5 TYPE A PER ASTM D2240
- 2.4 TOLERANCES: ±0.020 (0.508)

THESE DRAWINGS AND SPECIFICATIONS ARE THE PROPERTY OF MH CONNECTORS LTD. AND SHALL NOT BE REPRODUCED, COPIED OR USED AS THE BASIS FOR THE MANUFACTURE OR SALE OF APPARATUS WITHOUT WRITTEN PERMISSION.		DRAWN Haley	DATE 08-11-14
		APPROVED	DATE
SCALE	SHEET OF 1 OF 1	REV: 1.0	
DRAWING No DCMR37-ULP			



THIS SERIES FULLY CONFORMS TO THE EUROPEAN UNION DIRECTIVES 2002/95/EC AND 2002/96/EC FOR RoHS COMPLIANCY.



MH CONNECTORS LTD.