

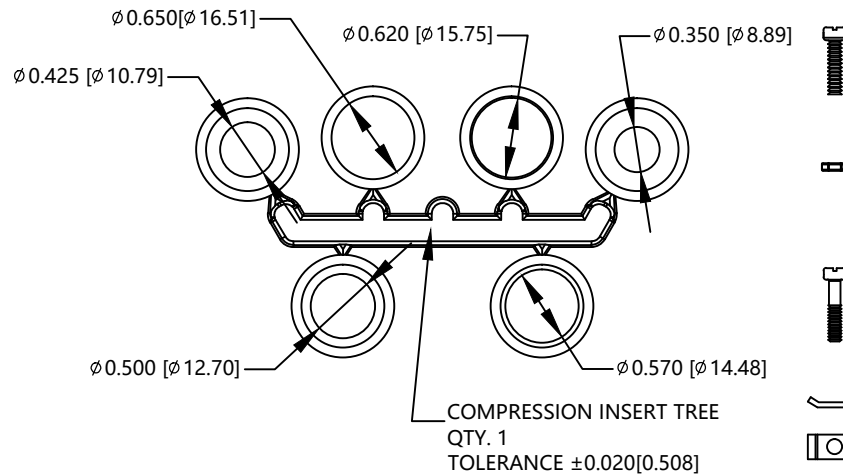

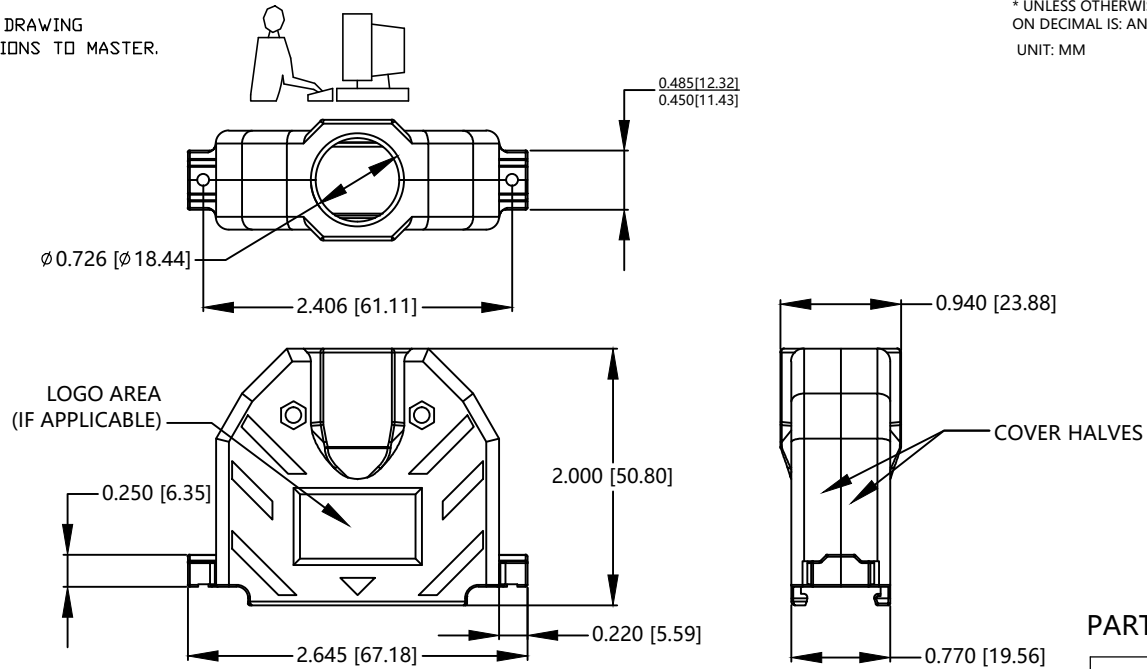

THIS IS A C.A.D. GENERATED DRAWING  
DO NOT MAKE MANUAL REVISIONS TO MASTER.

\* UNLESS OTHERWISE SPECIFIED TOLERANCES  
ON DECIMAL IS: ANGLE  
UNIT: MM X.  
X.X

ISSUE NUMBER

ORIGINAL ①



-  #4-40 X 7/16" FILLISTER HEAD MACHINE SCREW  
MATERIAL - STEEL  
FINISH - BRIGHT ZINC  
QTY: 2 EACH
-  #4-40 #2 BLANK HEX NUT  
MATERIAL - STEEL  
FINISH - BRIGHT ZINC  
QTY: 2 EACH
-  #4-40 x 1/2" FILLISTER HEAD MATING SCREW  
MATERIAL - STEEL  
FINISH - BRIGHT ZINC  
QTY: 2 EACH
-  #4 SADDLE WASHER  
MATERIAL - STEEL  
FINISH - BRIGHT ZINC  
QTY: 2 EACH

**PART NUMBER INFORMATION**

PART#	LOGO STYLE	SUPPLIED
C88E340000	NO LOGO	PACKAGED

CONNECTOR COVER:  
1.MATERIAL : ABS COMPOUND - UL94HB  
2.FINISH : NICKEL PLATING PER NTC  
SPECIFICATION N/T 000500  
3.DIMENSIONS : INCHES [MM]  
4.TOLERANCE : ±0.015 [0.381]

COMPRESSION INSERT TREE  
1.MATERIAL : THERMOPLASTIC  
2.COLOR : BLACK  
3.DUROMETER: 75±5 TYPE A PER ASTM D2240  
4.DIMENSIONS : INCHES [MM]  
5.TOLERANCE : ±0.020 [0.508]

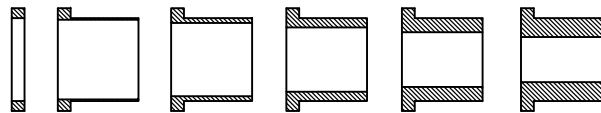

THESE DRAWINGS AND SPECIFICATIONS ARE THE PROPERTY OF MH CONNECTORS AND SHALL NOT BE REPRODUCED, COPIED OR USED AS THE BASIS FOR THE MANUFACTURE OR SALE OF APPARATUS WITHOUT WRITTEN PERMISSION.

DRAWN Henry Pan		DATE 2023/02/27
APPROVED		DATE
SCALE 1:1	SHEET OF 1 OF 1	REV: 1
DRAWING No MHC88E340000		



THIS SERIES FULLY CONFORMS TO THE EUROPEAN UNION DIRECTIVES 2015/863/EU AND 2011/65/EU FOR RoHS COMPLIANCY.



**MH CONNECTORS ,  
DIVISION OF EDAC**