

**LED NUMERIC DISPLAY, 1 DIGIT**
**BL-S100X-12XX**
**Features:**

- Ø 25.40mm (1.0") Single digit numeric display series, BI-COLOR TYPE
- Ø Low current operation.
- Ø Excellent character appearance.
- Ø Easy mounting on P.C. Boards or sockets.
- Ø I.C. Compatible.
- Ø ROHS Compliance.

**Electrical-optical characteristics: (Ta=25°C) (Test Condition: IF=20mA)**

Part No		Chip			VF Unit:V		Iv TYP.(mcd)
Common Cathode	Common Anode	Emitted Color	Material	$\lambda_p$ (nm)	Typ	Max	
BL-S100A-12SG-XX	BL-S100B-12SG-XX	Super Red	AlGaInP	660	2.10	2.50	80
		Green	GaP/GaP	570	2.20	2.50	92
BL-S100A-12EG-XX	BL-S100B-12EG-XX	Orange	GaAsP/GaP	635	2.10	2.50	92
		Green	GaP/GaP	570	2.20	2.50	92
BL-S100A-12DUG-X X	BL-S100B-12DUG-X X	Ultra Red	AlGaInP	660	2.10	2.50	120
		Ultra Green	AlGaInP	574	2.20	2.50	120
BL-S100A-12UEUG- XX	BL-S100B-12UEUG- XX	Ultra Orange	AlGaInP	630	2.10	2.50	95
		Ultra Green	AlGaInP	574	2.20	2.50	120

-XX: Surface / Lens color :

Number	0	1	2	3	4	5
Ref Surface Color	White	Black	Gray	Red	Green	
Epoxy Color	Water clear	White diffused	Red Diffused	Green Diffused	Yellow Diffused	

**Absolute maximum ratings (Ta=25°C)**

Parameter	S	G	E	D	UG	UE		Unit
Forward Current $I_F$	30	30	30	30	30	30		mA
Power Dissipation $P_d$	75	80	80	75	75	65		mW
Reverse Voltage $V_R$	5	5	5	5	5	5		V
Peak Forward Current $I_{PF}$ (Duty 1/10 @1KHZ)	150	150	150	150	150	150		mA
Operation Temperature $T_{OPR}$	-40 to +80							°C
Storage Temperature $T_{STG}$	-40 to +85							°C
Lead Soldering Temperature $T_{SOL}$	Max.260±5°C for 3 sec Max. (1.6mm from the base of the epoxy bulb)							°C

**LED NUMERIC DISPLAY, 1 DIGIT**

**BL-S100X-12XX**

**Package configuration & Internal circuit diagram**

**BL-S100X-12 Series**

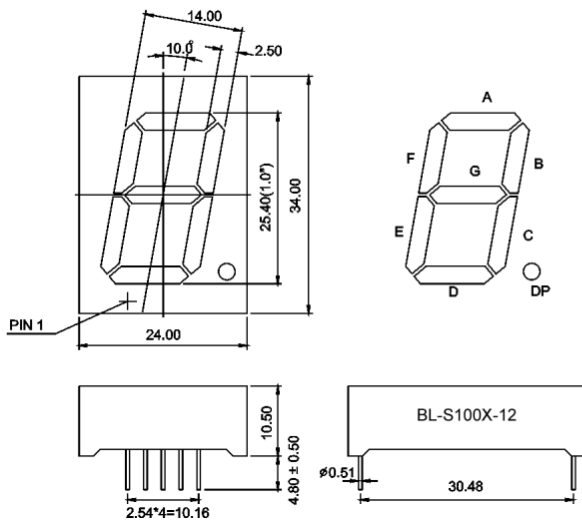

**BL-S100A-12xx**

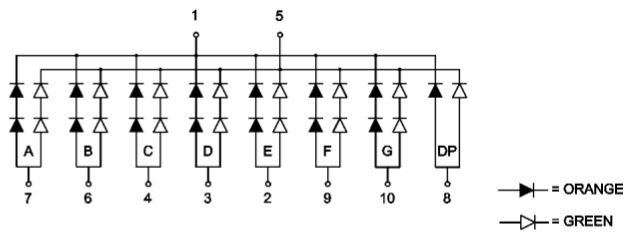

**BL-S100B-12xx**

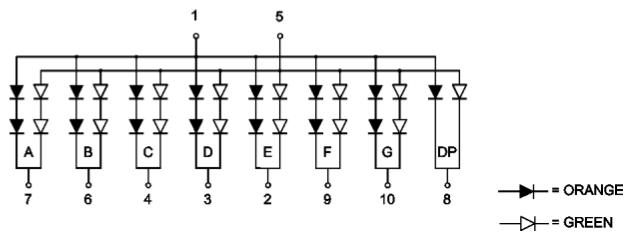

**Notes:**

1. All dimensions are in millimeters (inches)
2. Tolerance is  $\pm 0.25(0.01)$  unless otherwise noted.
3. Specifications are subject to change without notice.

**LED NUMERIC DISPLAY, 1 DIGIT**

**BL-S100X-12XX**

**Typical electrical-optical characteristics curves:**

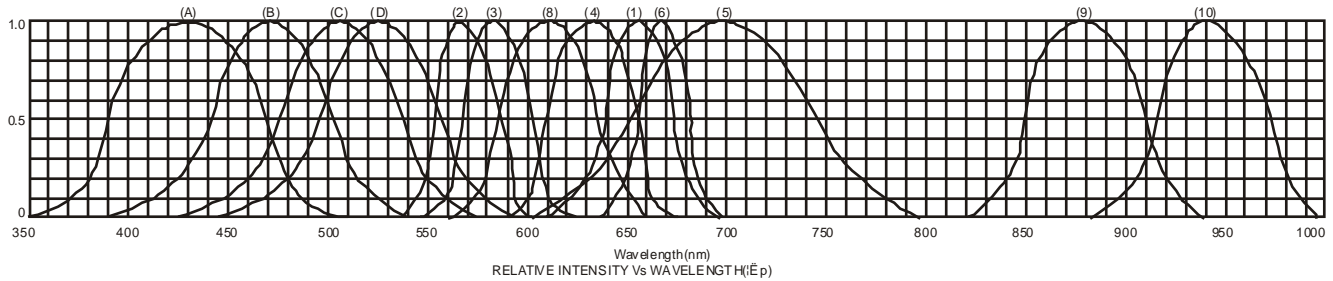

- (1) - GaAsP/GaAs 655nm/Red
- (2) - GaP 570nm/Yellow Green
- (3) - GaAsP/GaP 585nm/Yellow
- (4) - GaAsP/GaP 635nm/Orange & Hi-Eff Red
- (5) - GaP 700nm/Bright Red
- (6) - GaAlAs/GaAs 660nm/Super Red
- (8) - GaAsP/GaP 610nm/Super Red
- (9) - GaAlAs 880nm
- (10) - GaAs/GaAs & GaAlAs/GaAs 940nm
- (A) - GaN/SiC 430nm/Blue
- (B) - InGaN/SiC 470nm/Blue
- (C) - InGaN/SiC 505nm/Ultra Green
- (D) - InGaAlSiC 525nm/Ultra Green

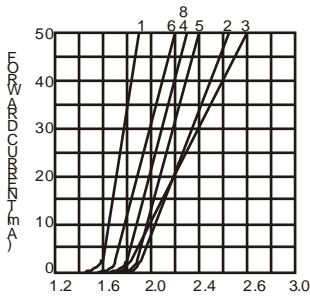

FORWARD VOLTAGE (Vf)  
FORWARD CURRENT VS.  
FORWARD VOLTAGE

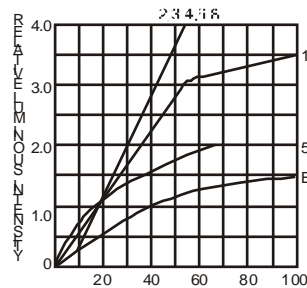

FORWARD CURRENT (mA)  
RELATIVE LUMINOUS  
INTENSITY VS. FORWARD  
CURRENT

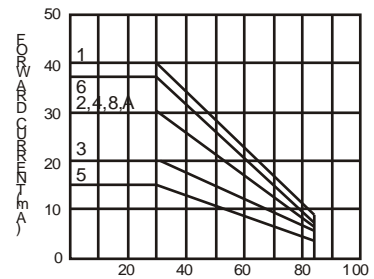

AMBIENT TEMPERATURE Ta ( °C )  
FORWARD CURRENT VS. AMBIENT  
TEMPERATURE

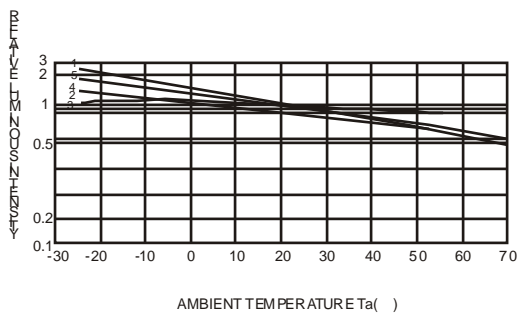

AMBIENT TEMPERATURE Ta ( °C )

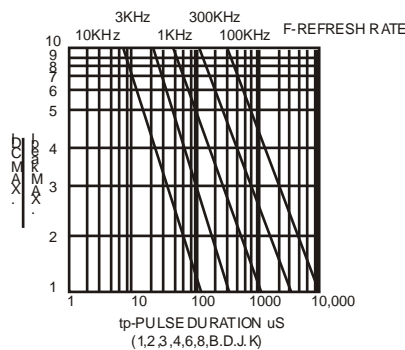

tp-PULSE DURATION  $\mu$ s  
(1,2,3,4,6,8,B,D,J,K)

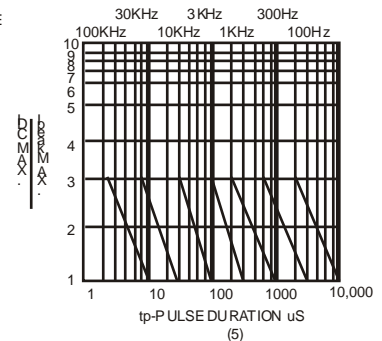

tp-PULSE DURATION  $\mu$ s  
(5)

NOTE: 25 free air temperature unless otherwise specified