

Bullet Type LED lamp

BL-L524

Features:

- Ø 5mm Round-Helmet Type LED Lamp
- Ø Ultra brightness.
- Ø Choice of various viewing angles.
- Ø Diffused, Transparent and Water clear lens are available.
- Ø IC compatible /Low current capability.
- Ø RoHs Compliance



Electrical-optical characteristics: (Ta=25°C) (Test Condition: IF=20mA)

Part Number	Chip			Lens Type	Forward Voltage(VF) Unit:V		Luminous Intensity (lv) Unit:mcd		Viewing Angle 2θ/2 (deg)
	Emitted Color	Material	λ _p (nm)		Typ	Max	Min.	Typ.	
					BL-L524UEC	Ultra Orange	AlGaInP	630	
BL-L524UYC	Ultra Yellow	AlGaInP	590	2.10	2.50	800	1500		
BL-L524UGC	Ultra Green	AlGaInP	574	2.20	2.50	300	800		
BL-L524PGC	Ultra Pure Green	InGaN	525	3.80	4.50	1500	3000		
BL-L524BGC	Ultra Bluish Green	InGaN	505	3.80	4.50	1000	2700		
BL-L524BC	Blue	InGaN	430	3.80	4.50	800	1500		
BL-L524UBC	Ultra Blue	InGaN	470	2.70	4.20	1200	2500		
BL-L524VC	UV	InGaN	405	3.80	4.50	60	90		
BL-L524UWC	Ultra White	InGaN	/	2.70	4.20	3000	10000		

Absolute maximum ratings (Ta=25°C)

Parameter	SR	LR	UR	UE	UY	UG	PG	BG	B	UB	UV	W	Unit
Forward Current I _F	25	25	25	30	30	30	30	30	30	30	30	30	mA
Power Dissipation P _d	60	60	60	65	65	75	110	110	120	120	120	120	mW
Reverse Voltage V _R	5	5	5	5	5	5	5	5	5	5	5	5	V
Peak Forward Current I _{PF} (Duty 1/10 @1KHZ)	150	150	150	150	150	150	150	100	100	100	100	100	mA
Operation Temperature T _{OPR}	-40 to +80												°C
Storage Temperature T _{STG}	-40 to +85												°C
Lead Soldering Temperature T _{SOL}	Max.260±5°C for 3 sec Max. (1.6mm from the base of the epoxy bulb)												°C

Bullet Type LED lamp

BL-L524

Package configuration & Internal circuit diagram

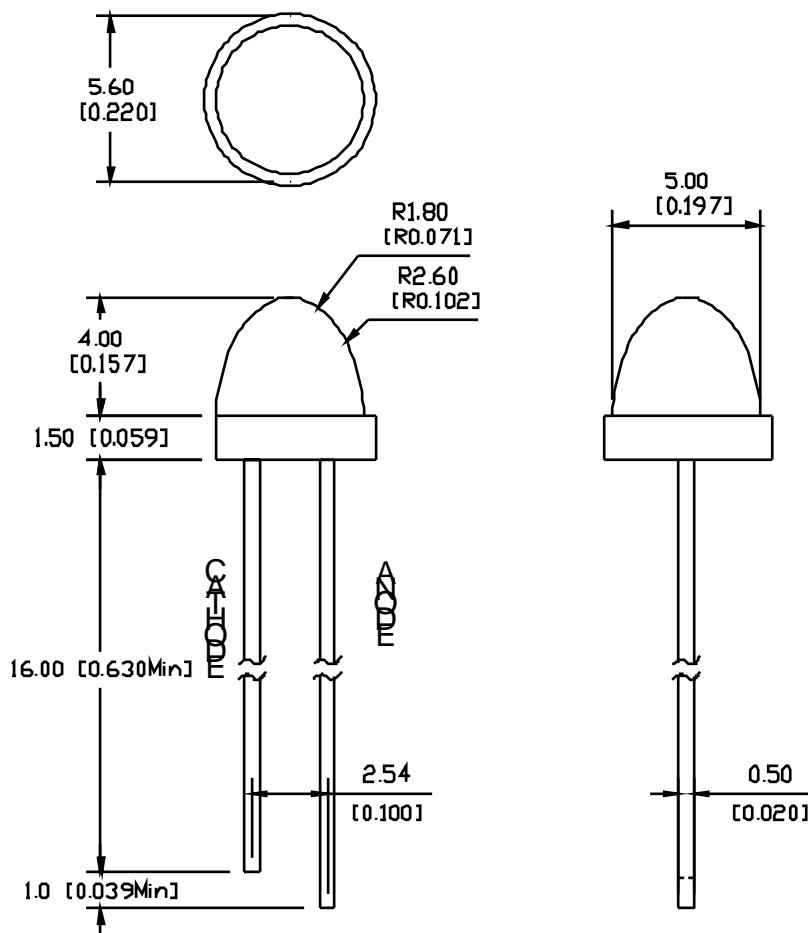

Notes:

1. All dimensions are in millimeters (inches)
2. Tolerance is ± 0.25 (0.01") unless otherwise noted.
3. Specifications are subject to change without notice.

Bullet Type LED lamp

BL-L524

Typical electrical-optical characteristics curves:

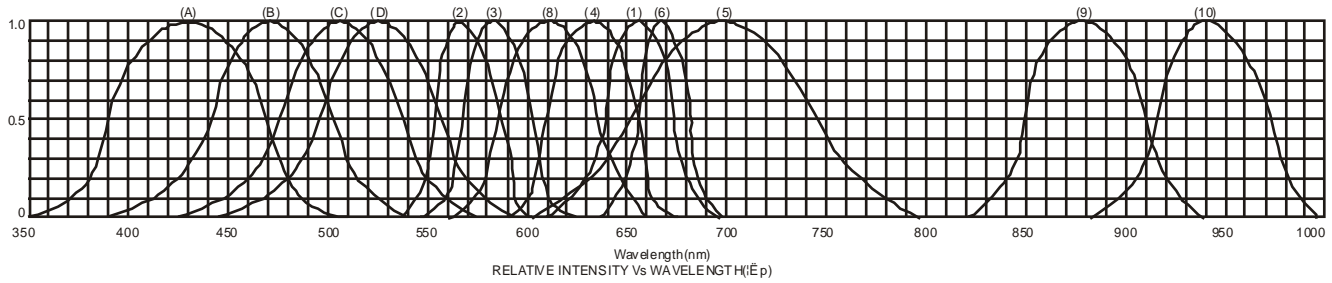

- (1) - GaAsP/GaAs 655nm/Red
- (2) - GaP 570nm/Yellow Green
- (3) - GaAsP/GaP 585nm/Yellow
- (4) - GaAsP/GaP 635nm/Orange & Hi-Eff Red
- (5) - GaP 700nm/Bright Red
- (6) - GaAlAs/GaAs 660nm/Super Red
- (8) - GaAsP/GaP 610nm/Super Red
- (9) - GaAlAs 880nm
- (10) - GaAs/GaAs & GaAlAs/GaAs 940nm
- (A) - GaN/SiC 430nm/Blue
- (B) - InGaN/SiC 470nm/Blue
- (C) - InGaN/SiC 505nm/Ultra Green
- (D) - InGaAlSiC 525nm/Ultra Green

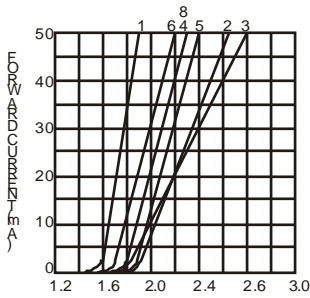

FORWARD VOLTAGE (Vf)
FORWARD CURRENT VS.
FORWARD VOLTAGE

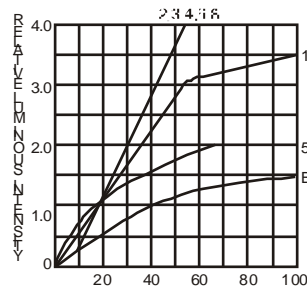

FORWARD CURRENT (mA)
RELATIVE LUMINOUS
INTENSITY VS. FORWARD
CURRENT

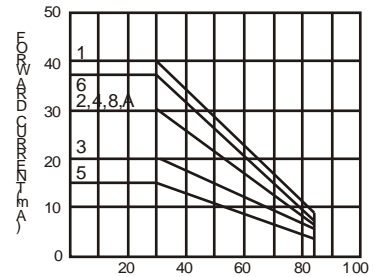

AMBIENT TEMPERATURE Ta (°C)
FORWARD CURRENT VS. AMBIENT
TEMPERATURE



AMBIENT TEMPERATURE Ta (°C)

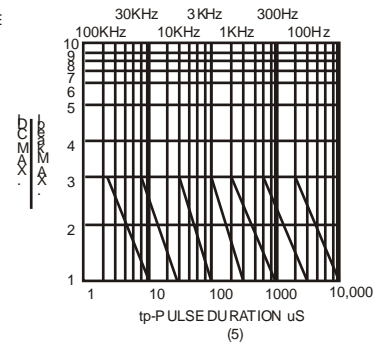
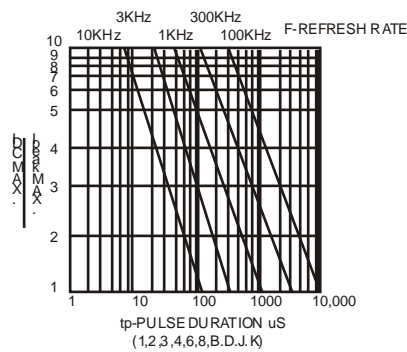

NOTE: 25 free air temperature unless otherwise specified

Bullet Type LED lamp

BL-L524

Packing and weighting

