

THIS IS A C.A.D. GENERATED DRAWING  
DO NOT MAKE MANUAL REVISIONS TO MASTER.



\* UNLESS OTHERWISE SPECIFIED TOLERANCES  
ON DECIMAL IS: ANGLE  $\pm 1^\circ$   
UNIT: MM X.  $\pm 0.5$   
.X  $\pm 0.3$   
.XX  $\pm 0.2$

BACKSHELL KIT INCLUDES:

- (2)BACKSHELL HALVES
- (2)4-40 SHELLSCREWS
- (2)NUTS
- (2)4-40 LONG JACKSCREW(MEL-VERSION)
- (1)SET OF COMPRESSION INSERTS-VARIOUS SIZES DIAMETERS 5mm,6mm,7mm,8mm,9mm

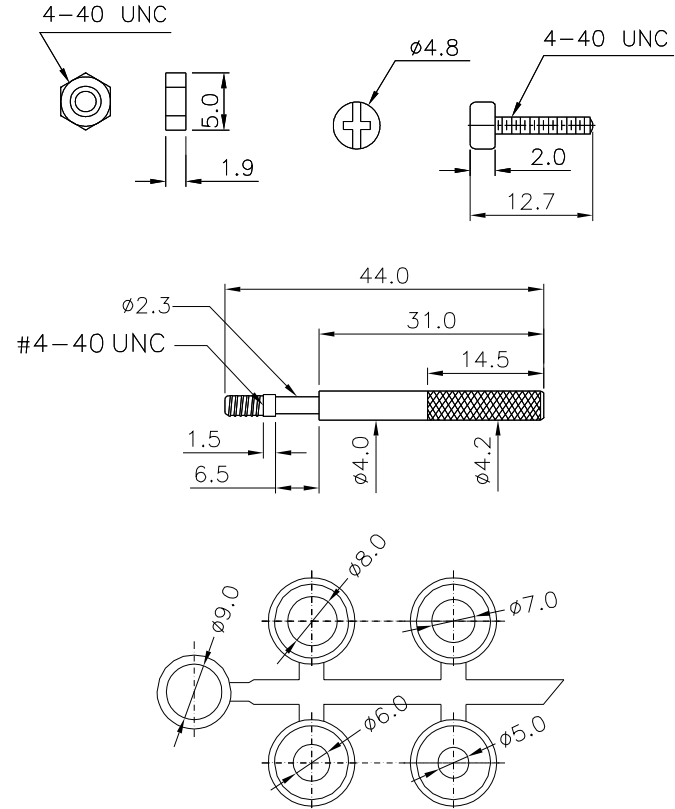
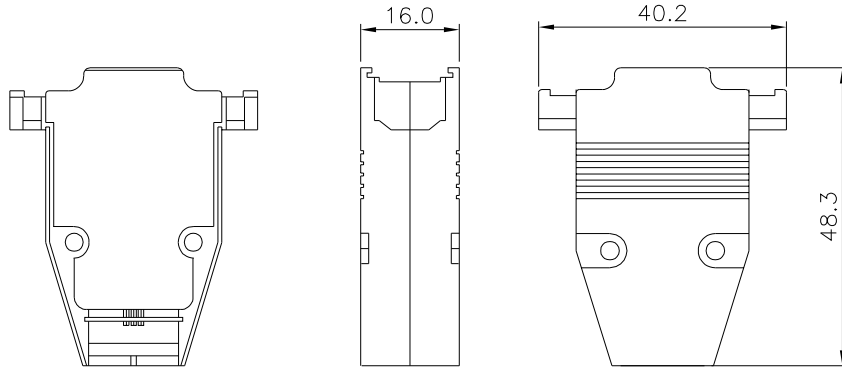

BACKSHELL MATERIAL: ZINC ALLOY  
PLATING: CHROMATE PLATED  
JACKSCREWS: STEEL  
SHELLSCREWS: STEEL

THESE DRAWINGS AND SPECIFICATIONS ARE THE PROPERTY OF MH CONNECTORS LTD. AND SHALL NOT BE REPRODUCED, COPIED OR USED AS THE BASIS FOR THE MANUFACTURE OR SALE OF APPARATUS WITHOUT WRITTEN PERMISSION.

<b>DRAWN</b> Change zhang	<b>DATE</b> 11-18-16
------------------------------	-------------------------

<b>APPROVED</b> Victor Lin	<b>DATE</b> 11-18-16
-------------------------------	-------------------------

<b>SCALE</b>	<b>SHEET OF</b> 1 OF 1	<b>REV:</b> 1.0
--------------	---------------------------	--------------------

**DRAWING No**  
MHCCOV15-MEL-RG



THIS SERIES FULLY CONFORMS TO THE EUROPEAN UNION DIRECTIVES 2002/95/EC AND 2002/96/EC FOR RoHS COMPLIANCY.



**MH CONNECTORS ,  
DIVISION OF EDAC**