

ARM Cortex™-M0 32-bit Microcontroller

NuTiny-SDK-M058S User Manual

For NuMicro M058S Series

The information described in this document is the exclusive intellectual property of Nuvoton Technology Corporation and shall not be reproduced without permission from Nuvoton.

Nuvoton is providing this document only for reference purposes of NuMicro™ microcontroller based system design. Nuvoton assumes no responsibility for errors or omissions.

All data and specifications are subject to change without notice.

For additional information or questions, please contact: Nuvoton Technology Corporation.

Table of Contents

1	Overview	3
2	Introduction to NuTiny-SDK- M058S	3
2.1	NuTiny-SDK- M058S Jumper Description	4
2.2	Pin Assignment for Extended Connectors	5
2.3	NuTiny-SDK-M058S PCB Placement	6
3	Starting to Use NuTiny-SDK-M058S on the Keil μ Vision [®] IDE	7
3.1	Downloading and Installing Keil μ Vision [®] IDE Software.....	7
3.2	Downloading and Installing Nuvoton Nu-Link Driver.....	7
3.3	Hardware Setup	7
3.4	Smpl_NuTiny-M051 Example Program.....	8
4	Starting to Use NuTiny-SDK-M058S on the IAR Embedded Workbench	9
4.1	Downloading and Installing IAR Embedded Workbench Software	9
4.2	Downloading and Installing Nuvoton Nu-Link Driver.....	9
4.3	Hardware Setup	9
4.4	Smpl_NuTiny-M051 Example Program.....	10
5	NuTiny-EVB-M058S Schematics	11
6	Downloading NuMicro [™] Related Files from Nuvoton Website	13
6.1	Downloading NuMicro [™] Keil μ Vision [®] IDE Driver	13
6.2	Downloading NuMicro[™] IAR EWARM Driver.....	14
6.3	Downloading NuMicro[™] M051 series BSP Software Library	15
7	Revision History	16

1 Overview

The NuTiny-SDK-M058S is a specific development tool for NuMicro M058S series by which users can develop and verify the application program easily. The NuTiny-SDK-M058S includes two portions: NuTiny-EVB-M058S (an evaluation board) and Nu-Link-Me (Debug Adaptor). With the NuTiny-SDK-M058S, users do not need additional ICE or debug equipment.

2 Introduction to NuTiny-SDK- M058S

The following figure shows the NuTiny-SDK-M058S for M058S series, in which the left portion is called NuTiny-EVB-M058S and the right portion is Debug Adaptor called Nu-Link-Me.

The NuTiny-EVB-M058S is similar to other development board. Users can use it to develop and verify applications to emulate the real behavior. In fact, the real chip M058S is mounted on the board. The NuTiny-EVB-M058S can be a real system controller to design user target system.

The Nu-Link-Me is a Debug Adaptor which connects the USB port of your PC to your target system (via Serial Wired Debug Port) and allows you to program and debug embedded programs on the target hardware. To use the Nu-Link-Me Debug adaptor with Keil or IAR, please refer to “Nuvoton NuMicro™ IAR ICE Driver User Manual” or Nuvoton NuMicro™ Keil ICE Driver User Manual” for details.

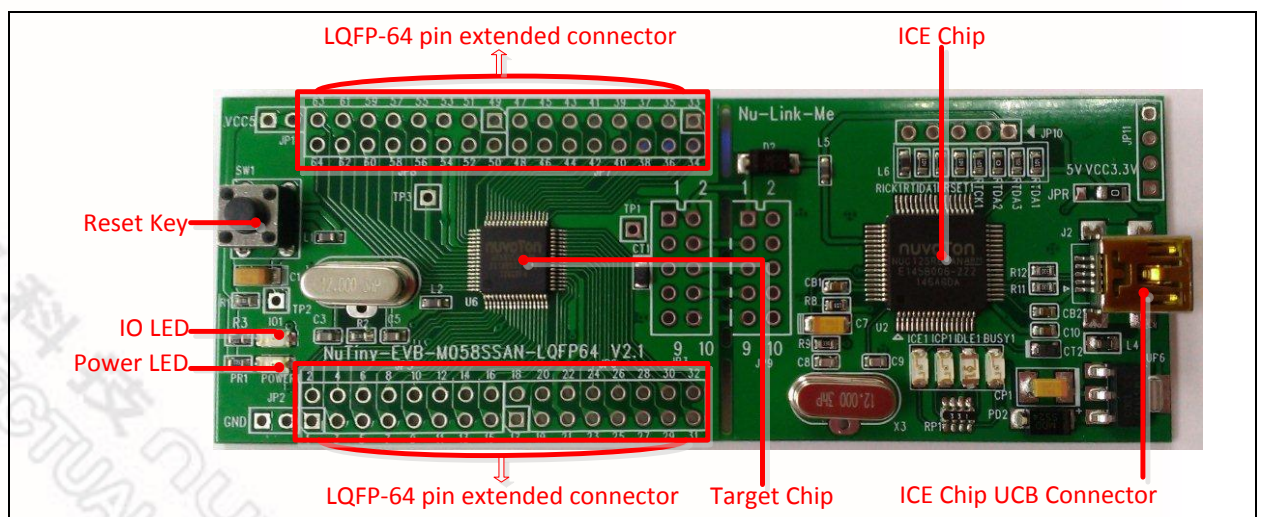

Figure 2-1 NuTiny-SDK-M058S (Green PCB Board)

2.1 NuTiny-SDK- M058S Jumper Description

2.1.1 Power Settings

- **JP1:** VCC5 Voltage connector in NuTiny-EVB-M058S
- **J2:** USB port in Nu-Link-Me

Model	J1 USB Port	J2 USB Port	JP1 VCC5	MCU Voltage
Model 1	X	Connect to PC	DC 3.3V output	DC 3.3V
Model 2	X	X	DC 2.5 V ~ 5.5 V Input	Voltage by VCC5 input

X: Unused.

2.1.2 Debug Connectors

- **JP3:** Target ICE Connector in NuTiny-EVB-M058S
- **JP9:** Nuvoton ICE Connector in Nu-Link-Me

2.1.3 USB Connectors

- **J2:** Mini USB Connector in Nu-Link-Me

2.1.4 Extended Connectors

- **JP5, JP6, JP7 and JP8:** Show all of chip pins in NuTiny-EVB-M058S

2.1.5 Buttons

- **SW1:** Reset button in NuTiny-EVB-M058S

2.1.6 Power Connectors

- **JP1:** VCC connector in NuTiny-EVB-M058S
- **JP2:** GND connector in NuTiny-EVB-M058S

2.2 Pin Assignment for Extended Connectors

The NuTiny-EVB- M058S provides the M058SSAN target chip on board and the extended connectors (**JP5**, **JP6**, **JP7** and **JP8**) for LQFP64-pin. The following table is the pin assignment for M058SSAN.

Pin No	Pin Name	Pin No	Pin Name
01	P1.5, MOSI_0, AIN5	33	P2.5
02	P1.6, MISO_0, AIN6	34	P2.6
03	P1.7, SPICLK0, AIN7	35	P2.7
04	/RST	36	P4.4, SCL1
05	P3.0, RXD	37	P4.5, SDA1
06	P5.0, T0EX	38	P4.6, ICE_CLK
07	P5.1, T1EX	39	P4.7, ICE_DAT
08	P5.2, SDA0	40	P6.0
09	P5.3, SCL0	41	P6.1
10	P3.1, TXD	42	P6.2
11	P3.2, /INT0, STADC, T0EX	43	P6.3
12	P3.3, /INT1, T1EX	44	P0.7, SPICLK0
13	P3.4, T0, SDA0	45	P0.6, MISO_0
14	P3.5 T1 SCL0, CKO	46	P0.5, MOSI_0
15	P4.3, PWM3	47	P0.4, SPISS0
16	P3.6, CKO	48	P4.1, PWM1, T3EX
17	P3.7	49	P0.3, RTS, RXD
18	XTAL2	50	P0.2, CTS, TXD
19	XTAL1	51	P0.1
20	VSS	52	P0.0
21	VDD	53	VSS
22	LDO_CAP	54	VDD
23	P5.4	55	P6.4
24	P5.5	56	P6.5
25	P5.6	57	P6.6
26	P5.7	58	P6.7
27	P2.0, PWM0	59	P1.0, T2, AIN0
28	P2.1, PWM1	60	P1.1, T3, AIN1
29	P2.2, PWM2	61	P1.2, AIN2
30	P2.3, PWM3	62	P1.3, AIN3
31	P2.4	63	P1.4, SPISS0, AIN4
32	P4.0, PWM0	64	P4.2, PWM2

Table 2-1 Pin Assignment for M058SSAN

2.3 NuTiny-SDK-M058S PCB Placement

The following figure shows the NuTiny-SDK- M058S PCB placement.

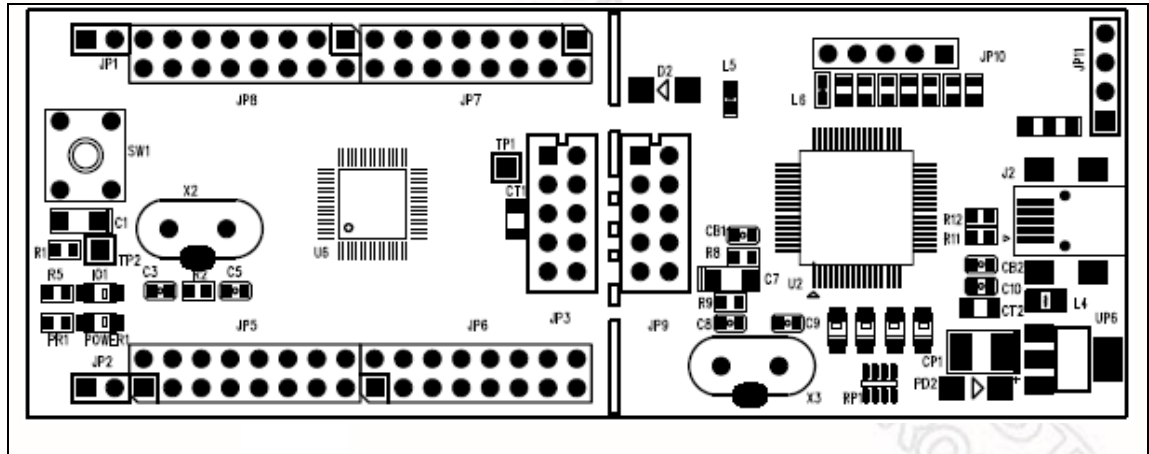

Figure 2-2 NuTiny-SDK-M058S PCB Placement

3 Starting to Use NuTiny-SDK-M058S on the Keil μ Vision[®] IDE

3.1 Downloading and Installing Keil μ Vision[®] IDE Software

Please visit the Keil company website (<http://www.keil.com>) to download the Keil μ Vision[®] IDE and install the RVMDK.

3.2 Downloading and Installing Nuvoton Nu-Link Driver

Please visit Nuvoton NuMicro[™] website (<http://www.nuvoton.com/NuMicro>) to download the “NuMicro[™] Keil μ Vision[®] IDE Driver” file. Please refer to [section 6.1](#) for the detailed download flow. After the Nu-Link driver is downloaded, please unzip the file and execute the “Nu-Link_Driver_for_keil_RVMDK_V1.23.6103.zip” to install the driver.

3.3 Hardware Setup

The hardware setup is shown in the following figure.



Figure 3-1 NuTiny-SDK-M058S Hardware Setup

3.4 Smpl_NuTiny-M051 Example Program

This example demonstrates how to download and debug an application on a NuTiny-SDK-M058S board.

The example file can be found in the directory list shown in the following figure.

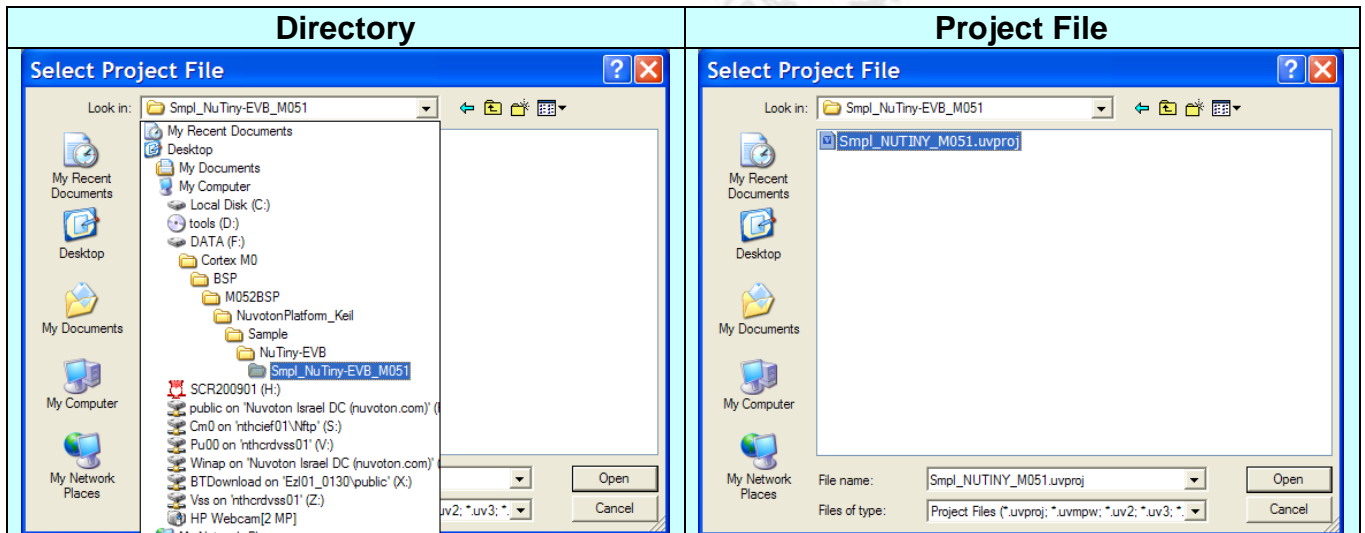

Figure 3-2 Smpl_NuTiny-M051 Example Directory

To use this example:

- **Start μ Vision[®]**
- **Project – Open**
Open the Smpl_NuTiny-M051.uvproj project file
- **Project – Build**
Compile and link the Smpl_NuTiny-M051 application
- **Flash – Download**
Program the application code into on-chip Flash ROM
- **Start Debug mode**
When using the debugger commands, you may:
 - ◆ Review variables in the watch window
 - ◆ Single step through code
 - ◆ Reset the device
 - ◆ Run the application

The P3.6 LED on the NuTiny-EVB-M058 board will be toggled on.

4 Starting to Use NuTiny-SDK-M058S on the IAR Embedded Workbench

4.1 Downloading and Installing IAR Embedded Workbench Software

Please visit the IAR company website (<http://www.iar.com>) to download the IAR Embedded Workbench and install the EWARM.

4.2 Downloading and Installing Nuvoton Nu-Link Driver

Please visit the Nuvoton Company NuMicro™ website (<http://www.nuvoton.com/NuMicro>) to download the “NuMicro™ IAR ICE Driver User Manual” file. Please refer to [section 6.2](#) for the detail download flow. When the download had finished, please unzip the file and execute the “Nu_Link_Driver_for_IAR_RVMDK_V1.23.6103.zip” to install the driver.

4.3 Hardware Setup

The hardware setup is shown in the following figure.

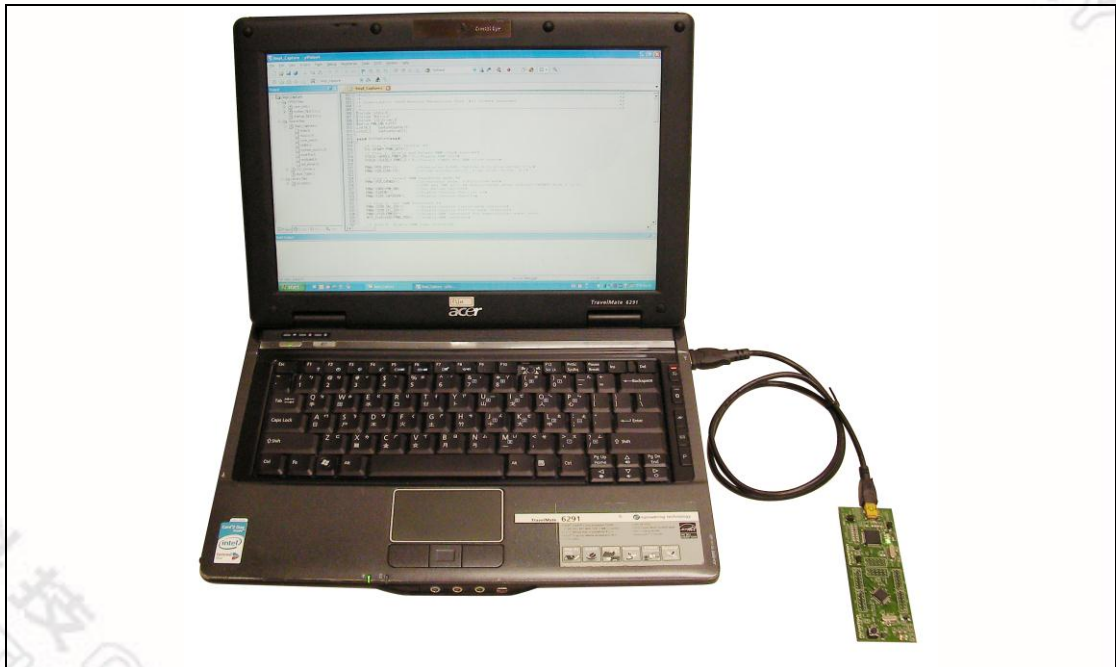

Figure 4-1 NuTiny-SDK-M058S Hardware Setup

4.4 Smpl_NuTiny-M051 Example Program

The example demonstrates how to download and debug an application on a NuTiny-SDK-M058S board.

The example can be found in the directory list shown in the following figure. (Sample code can be downloaded from Nuvoton website).

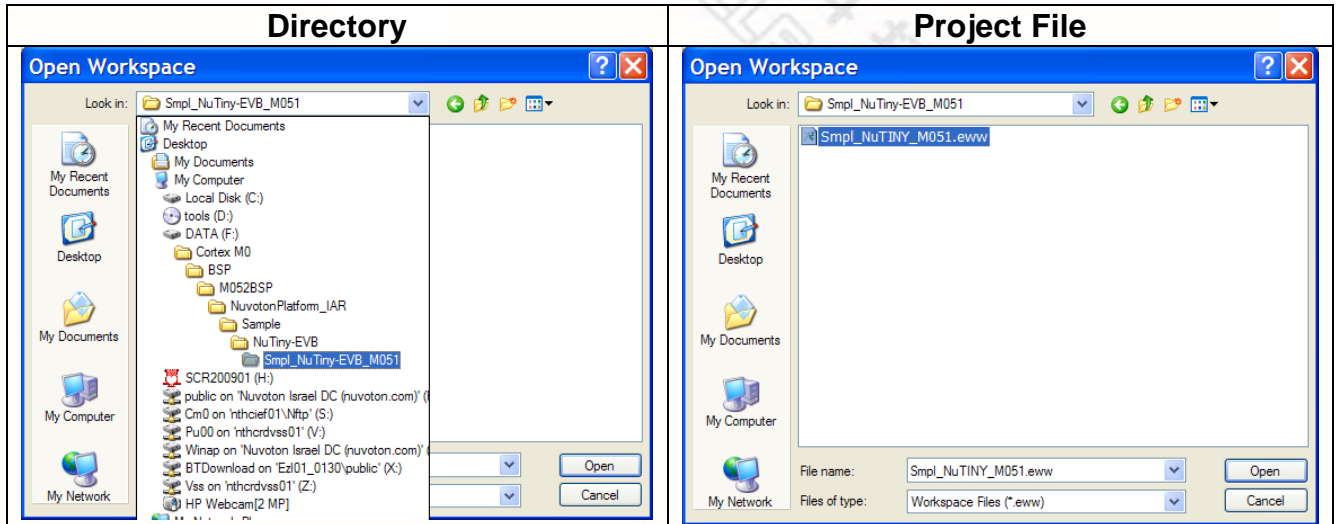





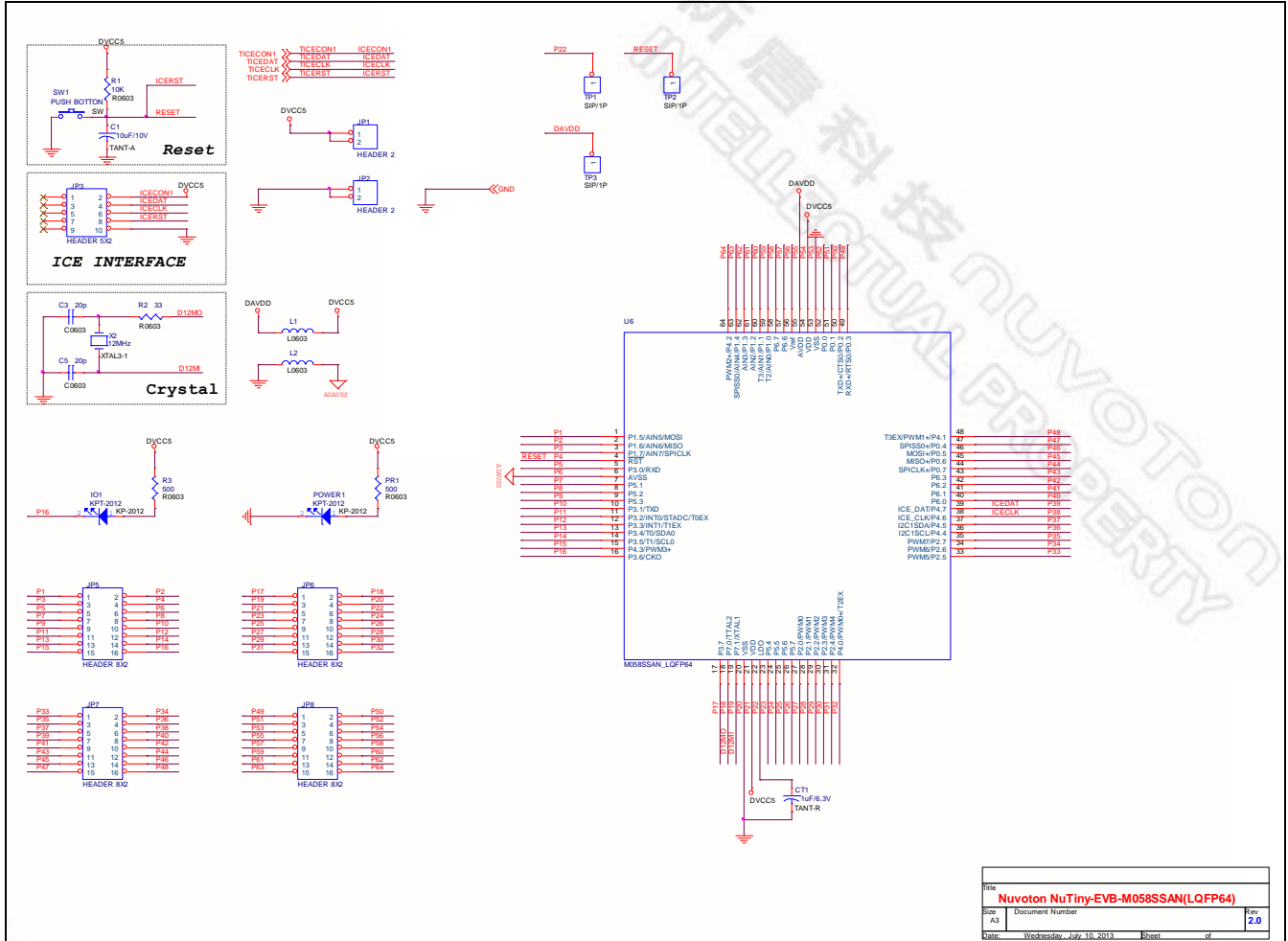

Figure 4-2 Smpl_NuTiny-M051 Example Directory

To use this example:

-  **Start IAR Embedded Workbench**
- **File-Open-Workspace**
Open the Smpl_NuTiny-M051.eww workspace file
-  **Project - Make**
Compile and link the Smpl_NuTiny-M051 application
The P3.6 LED on the NuTiny-EVB-M058S board will be toggled on.
-  **Project – Download and Debug**
Program the application code into on-chip Flash ROM
 - ◆  Single step through code
 - ◆  Reset the device
 - ◆  Run the application

5 NuTiny-EVB-M058S Schematics



Rev	Nuvoton NuTiny-EVB-M058SSAN(LQFP64)		Rev
Size	A3	Document Number	2.0
Date	Wednesday, July 10, 2013	Sheet	of

NuTiny-SDK-M058S User Manual

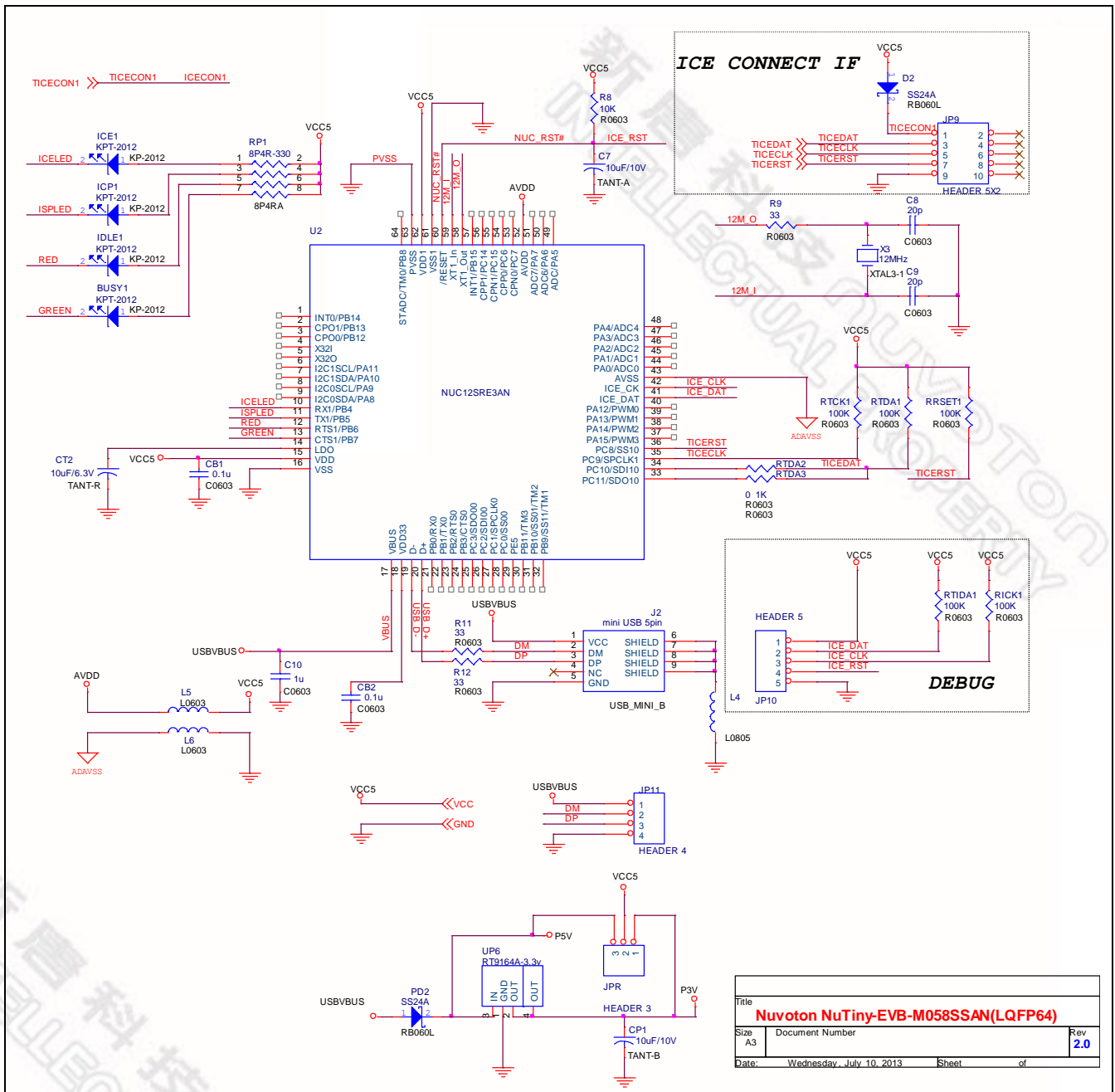

Title		
Nuvoton NuTiny-EVB-M058SSAN(LQFP64)		
Size	Document Number	Rev
A3		2.0
Date:	Wednesday, July 10, 2013	Sheet of

6 Downloading NuMicro™ Related Files from Nuvoton Website

6.1 Downloading NuMicro™ Keil μVision® IDE Driver

Step1	Visit the Nuvoton NuMicro™ Website: http://www.nuvoton.com/NuMicro																												
Step2																													
Step3	<p>Programmer Software Tools Package</p> <table border="1"> <thead> <tr> <th>File name</th> <th>Description</th> <th>Version</th> <th>Date</th> </tr> </thead> <tbody> <tr> <td> ICP Programming Tool V1.23.6103.zip Revision History</td> <td>NuMicro ICP tool & user manual</td> <td>V1.23.6103</td> <td>10-28-2013</td> </tr> <tr> <td> ISP Programming Tool V1.42.zip Revision History</td> <td>NuMicro ISP Programming Tool & user manual</td> <td>V1.42</td> <td>01-20-2012</td> </tr> <tr> <td> NuGang Programmer V6.19.zip Revision History</td> <td>NuGang Programmer & user manual</td> <td>V6.19</td> <td>11-01-2012</td> </tr> </tbody> </table> <p>Nu-Link Driver</p> <table border="1"> <thead> <tr> <th>File name</th> <th>Description</th> <th>Version</th> <th>Date</th> </tr> </thead> <tbody> <tr> <td> Nu-Link Driver for Keil RVMDK V1.23.6103.zip Revision History</td> <td>This driver is to support Nu-Link to work under Keil RVMDK Development Environment for all NuMicro Family Devices.</td> <td>V1.23..6103</td> <td>10-28-2013</td> </tr> <tr> <td> Nu-Link Driver for IAR EWARM V1.23.6103.zip Revision History</td> <td>This driver is to support Nu-Link to work under IAR EWARM Development Environment for all NuMicro Family Devices.</td> <td>V1.23..6103</td> <td>10-28-2013</td> </tr> </tbody> </table> <p>A yellow circle with an arrow points to the 'Nu-Link Driver for Keil RVMDK V1.23.6103.zip' entry with the text 'Downloading the file'.</p>	File name	Description	Version	Date	ICP Programming Tool V1.23.6103.zip Revision History	NuMicro ICP tool & user manual	V1.23.6103	10-28-2013	ISP Programming Tool V1.42.zip Revision History	NuMicro ISP Programming Tool & user manual	V1.42	01-20-2012	NuGang Programmer V6.19.zip Revision History	NuGang Programmer & user manual	V6.19	11-01-2012	File name	Description	Version	Date	Nu-Link Driver for Keil RVMDK V1.23.6103.zip Revision History	This driver is to support Nu-Link to work under Keil RVMDK Development Environment for all NuMicro Family Devices.	V1.23..6103	10-28-2013	Nu-Link Driver for IAR EWARM V1.23.6103.zip Revision History	This driver is to support Nu-Link to work under IAR EWARM Development Environment for all NuMicro Family Devices.	V1.23..6103	10-28-2013
File name	Description	Version	Date																										
ICP Programming Tool V1.23.6103.zip Revision History	NuMicro ICP tool & user manual	V1.23.6103	10-28-2013																										
ISP Programming Tool V1.42.zip Revision History	NuMicro ISP Programming Tool & user manual	V1.42	01-20-2012																										
NuGang Programmer V6.19.zip Revision History	NuGang Programmer & user manual	V6.19	11-01-2012																										
File name	Description	Version	Date																										
Nu-Link Driver for Keil RVMDK V1.23.6103.zip Revision History	This driver is to support Nu-Link to work under Keil RVMDK Development Environment for all NuMicro Family Devices.	V1.23..6103	10-28-2013																										
Nu-Link Driver for IAR EWARM V1.23.6103.zip Revision History	This driver is to support Nu-Link to work under IAR EWARM Development Environment for all NuMicro Family Devices.	V1.23..6103	10-28-2013																										
Step4	Download the NuMicro Keil uVision® IDE driver.																												

6.2 Downloading NuMicro™ IAR EWARM Driver

Step1	Visit the Nuvoton NuMicro™ Website: http://www.nuvoton.com/NuMicro																												
Step2	 <p>ARM Cortex™-M0 NuMicro® Family</p> <p>Click here to enter Device Driver page</p> <ul style="list-style-type: none"> Products <ul style="list-style-type: none"> MCU Products Brochure <ul style="list-style-type: none"> English Chinese DM Download Online Products Selection Our Track Record in Longevity <i>New!</i> Distributor Information Development Resources <ul style="list-style-type: none"> Products Brief, DataSheet Technical Reference Manual Development Tools <ul style="list-style-type: none"> Device Driver and Software Library NuMicro Development Tools Third Party Tools Migration Guide Application Notes Reference Design 																												
Step 3	<p>Programmer Software Tools Package</p> <table border="1" data-bbox="358 1094 1495 1346"> <thead> <tr> <th>File name</th> <th>Description</th> <th>Version</th> <th>Date</th> </tr> </thead> <tbody> <tr> <td> ICP Programming Tool V1.23.6103.zip Revision History</td> <td>NuMicro ICP tool & user manual</td> <td>V1.23.6103</td> <td>10-28-2013</td> </tr> <tr> <td> ISP Programming Tool V1.42.zip Revision History</td> <td>NuMicro ISP Programming Tool & user manual</td> <td>V1.42</td> <td>01-20-2012</td> </tr> <tr> <td> NuGang Programmer V6.19.zip Revision History</td> <td>NuGang Programmer software & user manual</td> <td>V6.19</td> <td>11-01-2012</td> </tr> </tbody> </table> <p>Nu-Link Driver</p> <table border="1" data-bbox="358 1423 1495 1619"> <thead> <tr> <th>File name</th> <th>Description</th> <th>Version</th> <th>Date</th> </tr> </thead> <tbody> <tr> <td> Nu-Link Driver for Keil RVMDK V1.23.6103.zip Revision History</td> <td>This driver is to support Nu-Link to work under Keil RVMDK Development Environment for all NuMicro Family Devices.</td> <td>V1.23..6103</td> <td>10-28-2013</td> </tr> <tr> <td> Nu-Link Driver for IAR EWARM V1.23.6103.zip Revision History</td> <td>This driver is to support Nu-Link to work under IAR EWARM Development Environment for all NuMicro Family Devices.</td> <td>V1.23..6103</td> <td>10-28-2013</td> </tr> </tbody> </table> <p>Downloading the file</p>	File name	Description	Version	Date	ICP Programming Tool V1.23.6103.zip Revision History	NuMicro ICP tool & user manual	V1.23.6103	10-28-2013	ISP Programming Tool V1.42.zip Revision History	NuMicro ISP Programming Tool & user manual	V1.42	01-20-2012	NuGang Programmer V6.19.zip Revision History	NuGang Programmer software & user manual	V6.19	11-01-2012	File name	Description	Version	Date	Nu-Link Driver for Keil RVMDK V1.23.6103.zip Revision History	This driver is to support Nu-Link to work under Keil RVMDK Development Environment for all NuMicro Family Devices.	V1.23..6103	10-28-2013	Nu-Link Driver for IAR EWARM V1.23.6103.zip Revision History	This driver is to support Nu-Link to work under IAR EWARM Development Environment for all NuMicro Family Devices.	V1.23..6103	10-28-2013
File name	Description	Version	Date																										
ICP Programming Tool V1.23.6103.zip Revision History	NuMicro ICP tool & user manual	V1.23.6103	10-28-2013																										
ISP Programming Tool V1.42.zip Revision History	NuMicro ISP Programming Tool & user manual	V1.42	01-20-2012																										
NuGang Programmer V6.19.zip Revision History	NuGang Programmer software & user manual	V6.19	11-01-2012																										
File name	Description	Version	Date																										
Nu-Link Driver for Keil RVMDK V1.23.6103.zip Revision History	This driver is to support Nu-Link to work under Keil RVMDK Development Environment for all NuMicro Family Devices.	V1.23..6103	10-28-2013																										
Nu-Link Driver for IAR EWARM V1.23.6103.zip Revision History	This driver is to support Nu-Link to work under IAR EWARM Development Environment for all NuMicro Family Devices.	V1.23..6103	10-28-2013																										
Step 4	Download the NuMicro™ IAR Embedded Workbench® driver.																												

6.3 Downloading NuMicro™ M051 series BSP Software Library

Step1	Visit the Nuvoton NuMicro™ Website: http://www.nuvoton.com/NuMicro
Step2	<p>ARM Cortex™-M0 NuMicro® Family</p> <p>Click here to enter Device Driver page</p> <ul style="list-style-type: none"> Products <ul style="list-style-type: none"> MCU Products Brochure <ul style="list-style-type: none"> English Chinese DM Download Online Products Selection Our Track Record in Longevity ^{New!} Distributor Information Development Resources <ul style="list-style-type: none"> Products Brief, DataSheet Technical Reference Manual Development Tools <ul style="list-style-type: none"> Device Driver and Software Library NuMicro Development Tools Third Party Tools Migration Guide Application Notes Reference Design
Step3	Download the NuMicro M051™ series software library.

7 Revision History

Revision	Date	Description
1.00	Oct.31, 2013	Initial release

Important Notice

Nuvoton products are not designed, intended, authorized or warranted for use as components in systems or equipment intended for surgical implantation, atomic energy control instruments, airplane or spaceship instruments, transportation instruments, traffic signal instruments, combustion control instruments, or for other applications intended to support or sustain life. Furthermore, Nuvoton products are not intended for applications wherein failure of Nuvoton products could result or lead to a situation wherein personal injury, death or severe property or environmental damage could occur.

Nuvoton customers using or selling these products for use in such applications do so at their own risk and agree to fully indemnify Nuvoton for any damages resulting from such improper use or sales.

Please note that all data and specifications are subject to change without notice. All the trademarks of products and companies mentioned in this datasheet belong to their respective owners.