

**ARM Cortex™-M0
32-bit Microcontroller**

**NuTiny-SDK-Nano130 User Manual
for NuMicro™ Nano130 Series**

The information described in this document is the exclusive intellectual property of Nuvoton Technology Corporation and shall not be reproduced without permission from Nuvoton.

Nuvoton is providing this document only for reference purposes of NuMicro™ microcontroller based system design. Nuvoton assumes no responsibility for errors or omissions.

All data and specifications are subject to change without notice.

For additional information or questions, please contact: Nuvoton Technology Corporation.

Table of Contents

1	Overview	3
2	Introduction to NuTiny-SDK-Nano130	3
2.1	NuTiny-SDK-Nano130 Jumper Description	4
2.2	Pin Assignment for Extended Connectors	5
2.3	NuTiny-SDK-Nano130 PCB Placement	7
3	Starting to Use NuTiny -SDK-Nano130 on the Keil μ Vision [®] IDE	8
3.1	Downloading and Installing Keil μ Vision [®] IDE Software.....	8
3.2	Downloading and Installing Nuvoton Nu-Link Driver.....	8
3.3	Hardware Setup.....	8
3.4	LCD_DEMO Example Program.....	9
4	Starting to Use NuTiny-SDK-Nano130 on the IAR Embedded Workbench.....	10
4.1	Downloading and Installing IAR Embedded Workbench Software	10
4.2	Downloading and Installing Nuvoton Nu-Link Driver.....	10
4.3	Hardware Setup.....	10
4.4	LCD_DEMO Example Program.....	11
5	NuTiny-EVB-Nano130 Schematics	12
6	Downloading NuMicro [™] Related Files from Nuvoton Website	14
6.1	Downloading NuMicro [™] Keil μ Vision [®] IDE Driver.....	14
6.2	Downloading NuMicro [™] IAR EWARM Driver.....	16
6.3	Downloading NuMicro [™] Nano100 series BSP Software Library	18
7	Revision History	19



1 Overview

The NuTiny-SDK-Nano130 is a specific development tool for the NuMicro Nano130 series users to develop and verify the application program easily. The NuTiny-SDK-Nano130 includes two portions: NuTiny-EVB-Nano130 (an evaluation board) and Nu-Link-Me (its Debug Adaptor), such that users do not need additional ICE or debug equipment.

2 Introduction to NuTiny-SDK-Nano130

The NuTiny-SDK-Nano130 uses the NANO130KE3BN as the target microcontroller. *Figure 2-1* shows the NuTiny-SDK-Nano130 for Nano130 series, in which the left portion is called NuTiny-EVB-Nano130 and the right portion is called Nu-Link-Me.

The NuTiny-EVB-Nano130 is similar to other development boards, by which users can develop and verify applications to emulate the real behavior. The on board chip covers Nano130 series features. The NuTiny-EVB-Nano130 can be a real system controller to design the users' target systems.

The Nu-Link-Me is a Debug Adaptor, which connects your PC's USB port to a target system (via Serial Wired Debug Port) and allows you to program and debug embedded programs on the target hardware. To use the Nu-Link-Me Debug adaptor with IAR or Keil, please refer to "Nuvoton NuMicro™ IAR ICE Driver User Manual" or "Nuvoton NuMicro™ Keil ICE Driver User Manual" for details. The two documents will be stored in the local hard disk when each is installed.

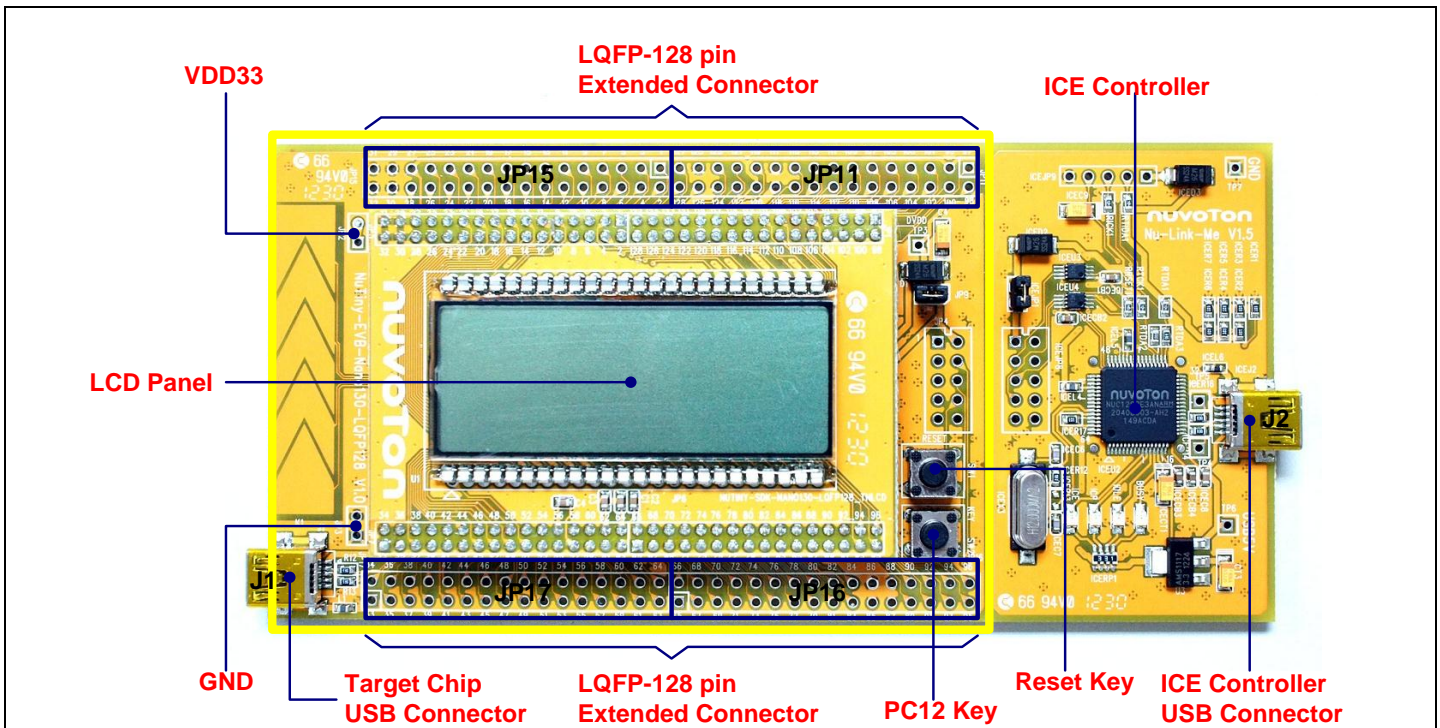

Figure 2-1 NuTiny-SDK-Nano130 (Yellow PCB Board)

2.1 NuTiny-SDK-Nano130 Jumper Description

2.1.1 Power Settings

- **J1**: USB port in NuTiny-EVB-Nano130
- **JP2**: VDD33 Voltage connector in NuTiny-EVB-Nano130
- **J2**: USB port in Nu-Link-Me

Power Model	J2 USB Port	J1 USB Port	JP2 VDD33	MCU Voltage
Model 1	Connect to PC	X	DC 3.3V output	DC 3.3V
Model 2	X	Connect to PC	DC3.3V output	DC 3.3V
Model 3	X	X	DC 1.8 V ~ 3.6 V Input	DC 1.8 V ~ 3.6 V Decided by JP2 VDD33 Input

X: Unused.

2.1.2 Debug Connectors

- **JP4**: Connector in target board (NuTiny-EVB-Nano130) for connecting with Nuvoton ICE adaptor (Nu-Link-Me)
- **JP8**: Connector in ICE adaptor (Nu-Link-Me) for connecting with a target board (e.g. NuTiny-EVB-Nano130)

2.1.3 USB Connectors

- **J1**: Mini USB Connector in NuTiny-EVB-Nano130 for application use
- **J2**: Mini USB Connector in Nu-Link-Me connected to a PC USB port

2.1.4 Extended Connectors

- **JP11, JP15, JP16 and JP17**: Show all chip pins in NuTiny-EVB-Nano130

2.1.5 Buttons

- **SW1**: Reset button in NuTiny-EVB-Nano130
- **SW2**: PC12 button in NuTiny-EVB-Nano130

2.1.6 Power Connectors

- **JP2**: VDD33 connector in NuTiny-EVB-Nano130
- **JP3**: GND connector in NuTiny-EVB-Nano130

2.1.7 Power Jumpers

- **JP1**: Jumper in ICE adaptor (Nu-Link-Me) for power source selection of **JP8**.
- **JP9**: Jumper in NuTiny-EVB-Nano130 to set power source from **JP4** and **J1**



2.2 Pin Assignment for Extended Connectors

The NuTiny-EVB-Nano130 provides the NANO130KE3BN target chip on board and the extended connectors (**JP11**, **JP15**, **JP16** and **JP17**) for LQFP128-pin.

No	Pin Name	No	Pin Name	No	Pin Name	No	Pin Name
01	PE13/LCD_SEG27	33	PE12/UART1_CTSn	65	PE4/SPI0_MOSI0	97	VREF
02	PB14/INT0/SC2_CD/ SPI2_SS1/LCD_SEG12/ LCD_SEG26	34	PE11/UART1_RTSn	66	PE3/SPI0_MISO0	98	NC
03	PB13/EBI_AD1/ LCD_SEG11/LCD_SEG25	35	PE10/UART1_TXD	67	PE2/SPI0_CLK	99	AVDD
04	PB12/EBI_AD0/ CLKO/LCD_SEG10/ LCD_SEG24	36	PE9/UART1_RXD	68	PE1/PWM1_CH3/SPI0_SS0	100	PD0/UART1_RXD/ SPI2_SS0/SC1_CLK/ CTK0/AD8
05	NC	37	PE8/LCD_SEG9	69	PE0/PWM1_CH2/ I2S_MCLK	101	PD1/UART1_TXD/ SPI2_CLK/SC1_DAT/ AD9/CTK1
06	X320	38	PE7/LCD_SEG8	70	PC13/SPI_MOSI1/ PWM1_CH1/SNOOPER/ INT0/I2C0_SCL	102	PD2/UART1_RTSn/ I2S_LRCLK/SPI2_MISO0/ SC1_PWR/AD10/CTK2
07	X32I	39	NC	71	PC12/SPI1_MISO1/ PWM1_CH0/ INT0/I2C0_SDA	103	PD3/UART1_CTSn/ I2S_BCLK/SPI2_MOSI0/ SC1_RST/AD11/CTK3
08	NC	40	NC	72	PC11/SPI1_MOSI0/ UART1_TXD/ CTK15/LCD_SEG31	104	NC
09	PA11/I2C1_SCL/EBI_nRD/ SC0_RST/SPI2_MOSI0/ LCD_SEG9/LCD_SEG23	41	NC	73	PC10/SPI1_MISO0/ UART1_RXD/ CTK14/LCD_SEG30	105	PD4/I2S_DI/ SPI2_MISO1/SC1_CD/ CTK4/LCD_SEG35
10	PA10/I2C1_SDA/EBI_nWR/ SC0_PWR/SPI2_MISO0/ LCD_SEG8/LCD_SEG22	42	NC	74	PC9/SPI1_CLK/I2C1_SCL/ CTK13/LCD_SEG29	106	PD5/I2S_DO/ SPI2_MOSI1/CTK5/ LCD_SEG34
11	PA9/I2C0_SCL/ SC0_DAT/SPI2_CLK/ LCD_SEG7/LCD_SEG21	43	NC	75	PC8/SPI1_SS0/ EBI_MCLK/I2C1_SDA/ CTK12/LCD_SEG28	107	PC7/DA1_OUT/ EBI_AD5/TC1/ PWM0_CH1/LCD_SEG17
12	PA8/I2C0_SDA/ SC0_CLK/SPI2_SS0/ LCD_SEG6/LCD_SEG20	44	PB0/UART0_RXD/ SPI1_MOSI0/ LCD_SEG1/LCD_SEG7	76	PA15/PWM0_CH3/ I2S_MCLK/TC3/SC0_PWR/ UART0_TXD/LCD_SEG27	108	PC6/DA0_OUT/ EBI_AD4/TC0/ SC1_CD/PWM0_CH0
13	PD8/LCD_SEG19	45	PB1/UART0_TXD/ SPI1_MISO0/ LCD_SEG0/LCD_SEG6	77	PA14/PWM0_CH2/ EBI_AD15/TC2/ UART0_RXD/LCD_SEG26	109	PC15/EBI_AD3/ TC0/PWM1_CH2/ LCD_SEG16/LCD_SEG33
14	PD9/LCD_SEG18	46	PB2/UART0_RTSn/ EBI_nWRL/SPI1_CLK/ LCD_COM3/LCD_SEG 5	78	PA13/PWM0_CH1/ EBI_AD14/TC1/I2C0_SCL/ CTK11/LCD_SEG25	110	PC14/EBI_AD2/ PWM1_CH3/ LCD_SEG15/LCD_SEG32
15	PD10/LCD_SEG17	47	PB3/UART0_CTSn/ EBI_nWRH/SPI1_SS0/ LCD_COM2/LCD_SEG 4	79	PA12/PWM0_CH0/ EBI_AD13/TC0/I2C0_SDA/ CTK10/LCD_SEG24	111	PB15/INT1/ SNOOPER/ LCD_SEG14/LCD_SEG31
16	PD11/LCD_SEG16	48	PD6/LCD_SEG3	80	PF0/ICE_DAT/INT0	112	NC
17	PD12/LCD_SEG15	49	PD7/LCD_SEG2	81	PF1/ICE_CLK/ CLKO/INT1	113	XT1_IN
18	PD13/LCD_SEG14	50	PD14/LCD_SEG1	82	NC	114	XT1_OUT
19	PB4/UART1_RXD/ SC0_CD/SPI2_SS0/ LCD_SEG5/LCD_SEG13	51	PD15/LCD_SEG0	83	VDD	115	NC
20	PB5/UART1_TXD/ LCD_SEG4	52	PC5/SPI0_MOSI1/ LCD_SEG3	84	NC	116	nRESET



	SC0_RST/SPI2_CLK/ LCD_SEG4/LCD_SEG12		LCD_COM3				
21	PB6/UART1_RTSn/ EBI_ALE/SPI2_MISO0/ LCD_SEG3/LCD_SEG11	53	PC4/SPI0_MISO1/ LCD_COM2	85	VSS	117	VSS
22	PB7/UART1_CTSn/ EBI_nCS/SPI2_MOSI0/ LCD_SEG2/LCD_SEG10	54	PC3/SPI0_MOSI0/ I2S_DO/SC1_RST/ LCD_COM1	86	VSS	118	VSS
23	NC	55	PC2/SPI0_MISO0/ I2S_DI/SC1_PWR/ LCD_COM0	87	AVSS	119	NC
24	LDO_CAP	56	PC1/SPI0_CLK/ I2S_BCLK_SC1_DAT/ LCD_DH2	88	AVSS	120	VDD
25	NC	57	PC0/SPI0_SS0/ I2S_LRCLK/ SC1_CLK/LCD_DH1	89	PA0/AD0/ SC2_CD/CTK8	121	NC
26	NC	58	PE6	90	PA1/AD1/EBI_AD12/CTK9	122	PF4/I2C0_SDA/CTK6
27	VDD	59	LCD_VLCD	91	PA2/AD2/EBI_AD11/ UART1_RXD/LCD_SEG23	123	PF5/I2C0_SCL/CTK7
28	NC	60	LCD_VLCD	92	PA3/AD3/EBI_AD10/ UART1_TXD/LCD_SEG22	124	VSS
29	VSS	61	PE5	93	PA4/AD4/EBI_AD9/ SC2_PWR/I2C0_SDA/ LCD_SEG21/LCD_SEG39	125	PVSS
30	VSS	62	PB11/PWM1_CH0/ TM3/SC2_DAT/ SPI0_MISO0/LCD_V1	94	PA5/AD5/EBI_AD8/ SC2_RST_I2C0_SCL/ LCD_SEG20/LCD_SEG38	126	PB8/STADC/TM0/ INT0/SC2_PWR/ LCD_SEG13/LCD_SEG30
31	VSS	63	PB10/SPI0_SS1/ TM2/SC2_CLK/ SPI0_MOSI0/LCD_V2	95	PA6/AD6/EBI_AD7/ TC3/SC2_CLK/PWM0_CH3/ LCD_SEG19/LCD_SEG37	127	PE15/LCD_SEG29
32	VSS	64	PB9/SPI1_SS1/ TM1/SC2_RST/ INT0/LCD_V3	96	PA7/AD7/EBI_AD6/ TC2/SC2_DAT/ PWM0_CH2/CTK_CAP/ LCD_SEG18/LCD_SEG36	128	PE14/LCD_SEG28

Table 2-1 NANO130KE3BN LQFP 128-pin Assignment for Extended Connectors

2.3 NuTiny-SDK-Nano130 PCB Placement

The following figure shows the NuTiny-SDK-Nano130 PCB placement.

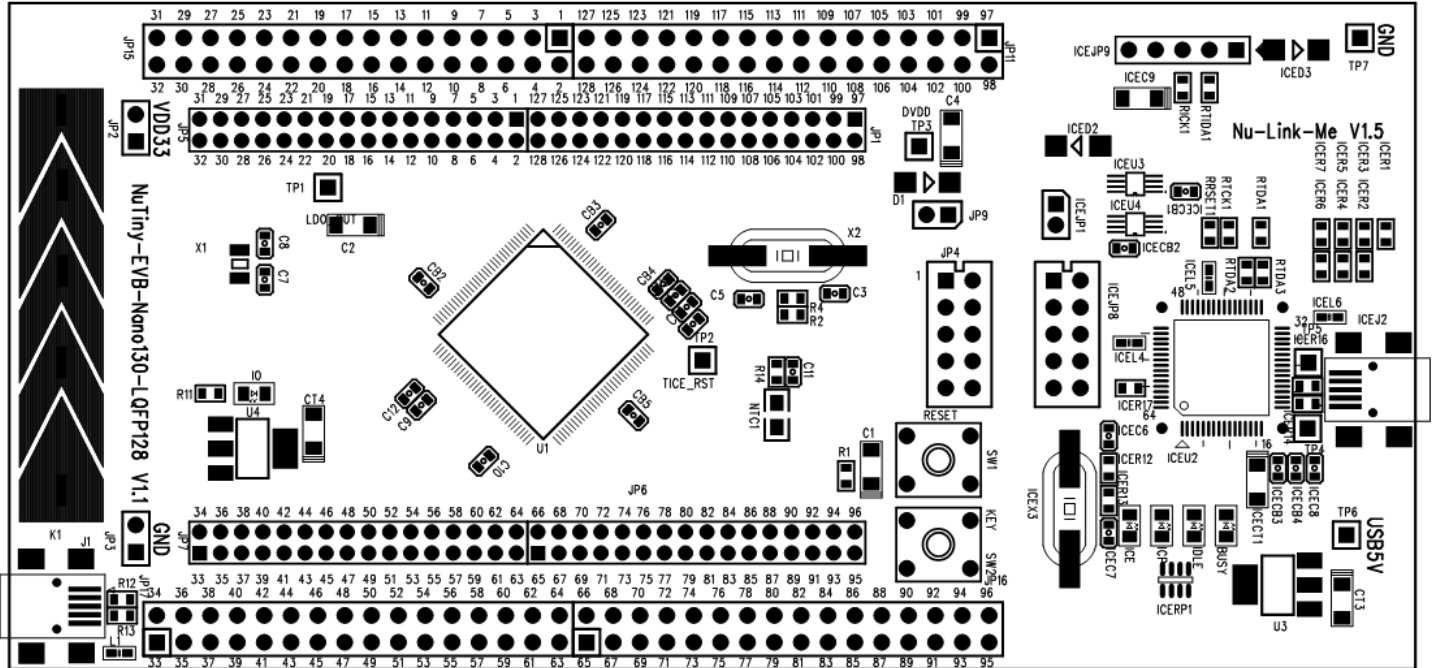

Figure 2-2 NuTiny-SDK-Nano130 PCB Placement

3 Starting to Use NuTiny -SDK-Nano130 on the Keil μ Vision[®] IDE

3.1 Downloading and Installing Keil μ Vision[®] IDE Software

Please connect to the Keil company website (<http://www.keil.com>) to download the Keil μ Vision[®] IDE and install the RVMDK.

3.2 Downloading and Installing Nuvoton Nu-Link Driver

Please connect to Nuvoton NuMicro[™] website (<http://www.nuvoton.com/NuMicro>) to download the “NuMicro[™] Keil μ Vision[®] IDE driver” file. Please refer to *section 6.1* for the detailed download flow. After the Nu-Link driver is downloaded, please unzip the file and execute the “Nu-Link_Keil_Driver.exe” to install the driver.

3.3 Hardware Setup

The hardware setup is shown in the following figure.

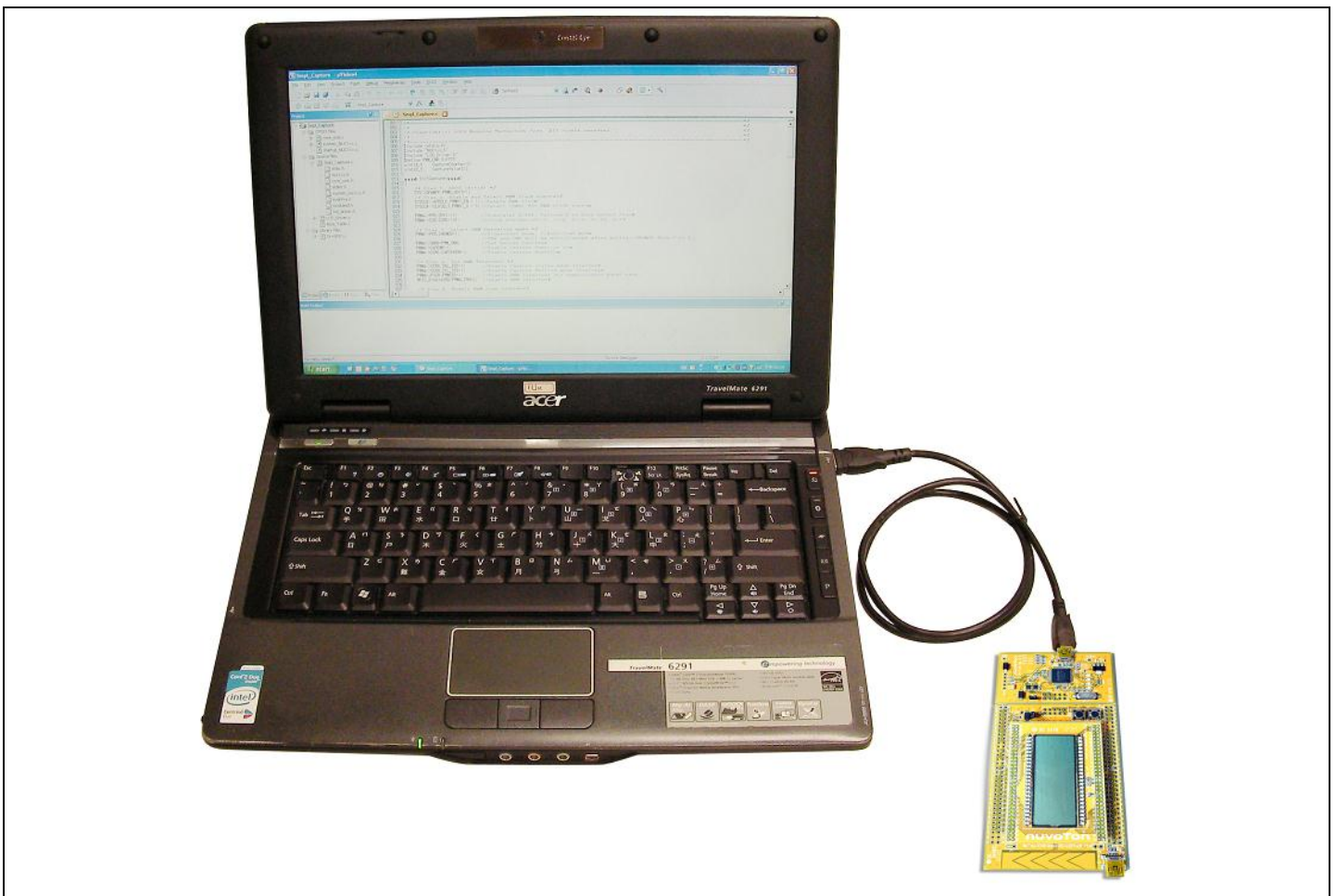

Figure 3-1 NuTiny-SDK-Nano130 Hardware Setup

3.4 LCD_DEMO Example Program

This example, as shown in the directory of *Figure 3-2*, demonstrates the download and debugging of an application on a NuTiny-SDK-Nano130 board. The example file can be downloaded from Nuvoton NuMicro™ website as described in *6.3 Downloading NuMicro™ Nano100 series BSP Software Library*.

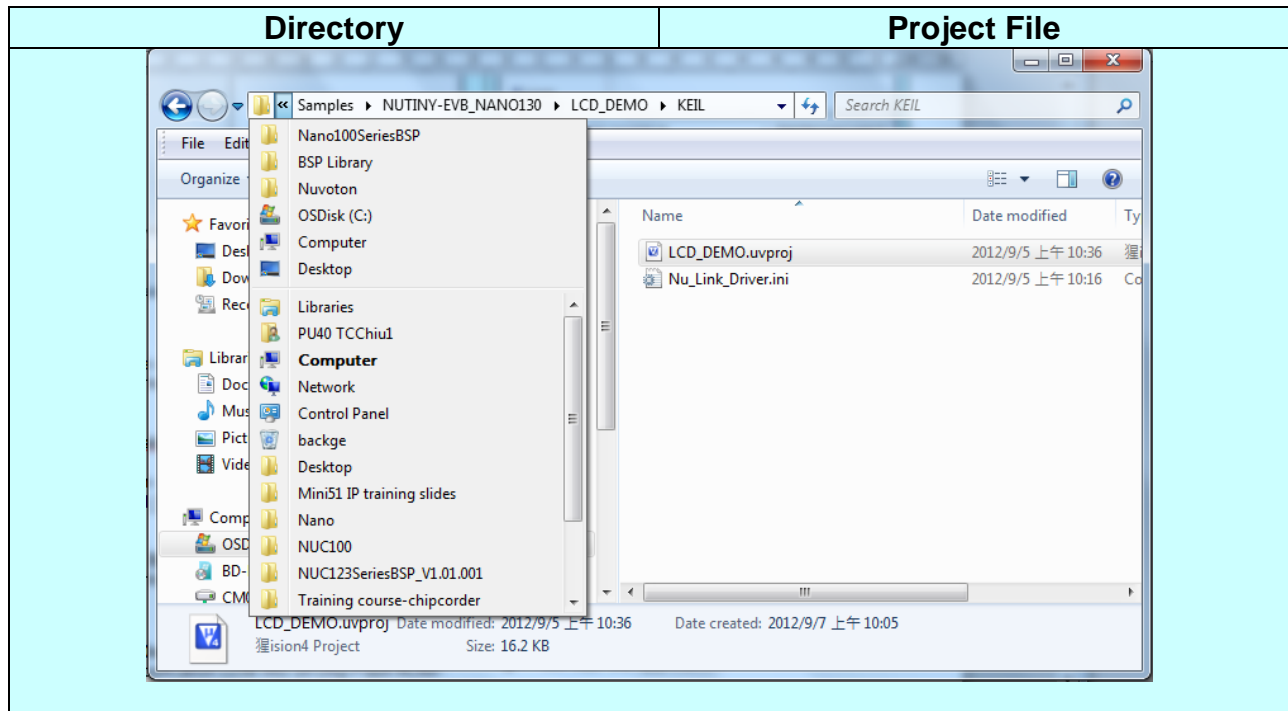









Figure 3-2 LCD_DEMO Example Directory

To use this example:

The LCD panel on the NuTiny-EVB-Nano130 board will display a NUVOTON logo.

-  **Start µVision®**
- **Project-Open**
Open the LCD_DEMO.uvproj project file
-  **Project - Build**
Compile and link the LCD_DEMO application
-  **Flash – Download**
Program the application code into on-chip Flash ROM
-  **Start Debug mode**
When using the debugger commands, you may:
 - ◆  Review variables in the watch window
 - ◆  Single step through code
 - ◆  RST Reset the device
 - ◆  Run the application

4 Starting to Use NuTiny-SDK-Nano130 on the IAR Embedded Workbench

4.1 Downloading and Installing IAR Embedded Workbench Software

Please connect to IAR company website (<http://www.iar.com>) to download the IAR Embedded Workbench and install the EWARM.

4.2 Downloading and Installing Nuvoton Nu-Link Driver

Please connect to Nuvoton Company NuMicro™ website (<http://www.nuvoton.com/NuMicro>) to download the “NuMicro™ IAR ICE Driver User Manual” file. Please refer to section 6.2 for the detailed download flow. When the Nu-Link driver has been well downloaded, please unzip the file and execute the “Nu-Link_IAR_Driver.exe” to install the driver.

4.3 Hardware Setup

The hardware setup is shown in the following figure.

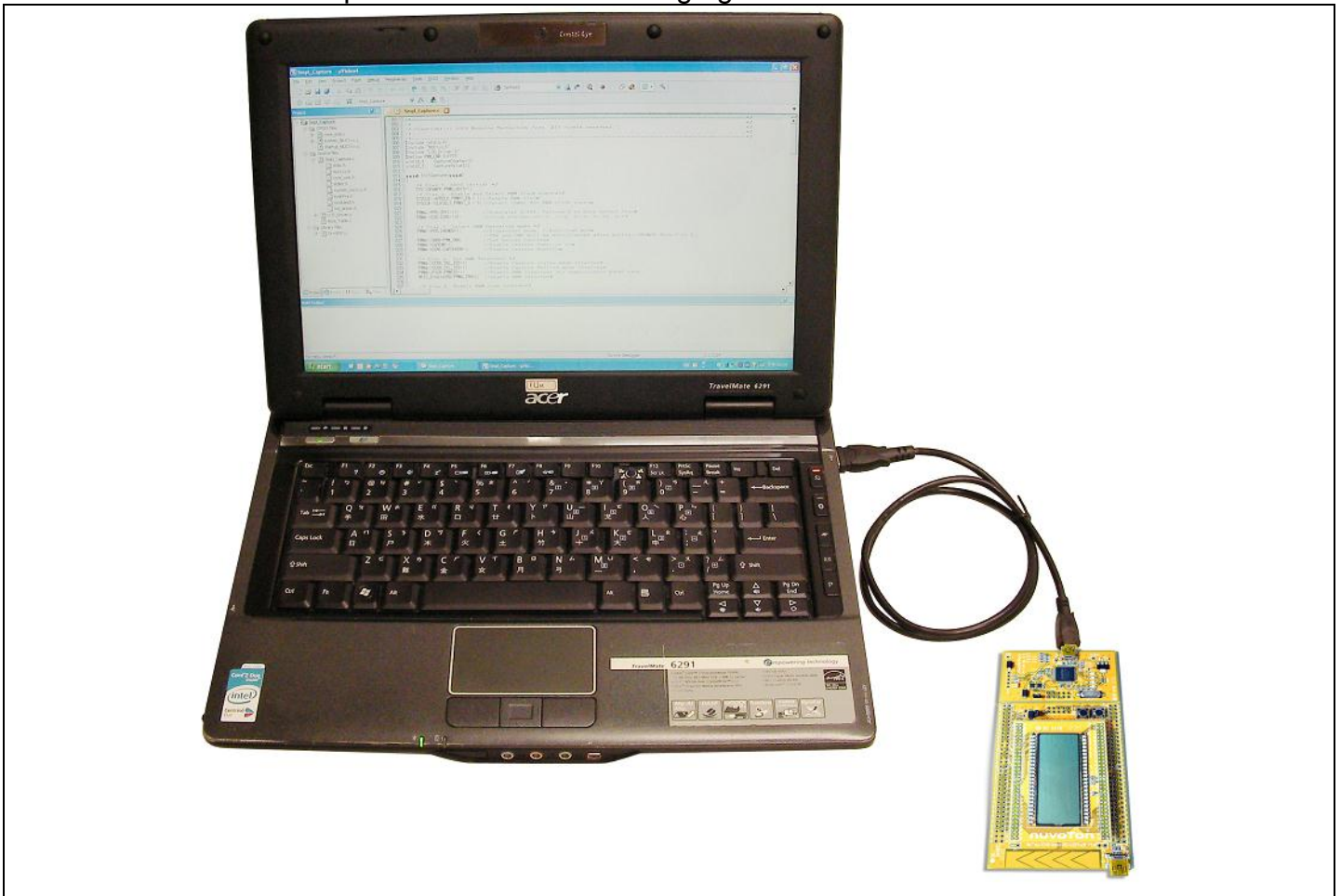

Figure 4-1 NuTiny- SDK-Nano130 Hardware Setup

4.4 LCD_DEMO Example Program

The example, as shown in the directory of *Figure 4-2*, demonstrates the download and debugging of an application on a NuTiny-SDK-Nano130 board. The example file can be downloaded from Nuvoton NuMicro™ website as described in *6.3 Downloading NuMicro™ Nano100 series BSP Software Library*.

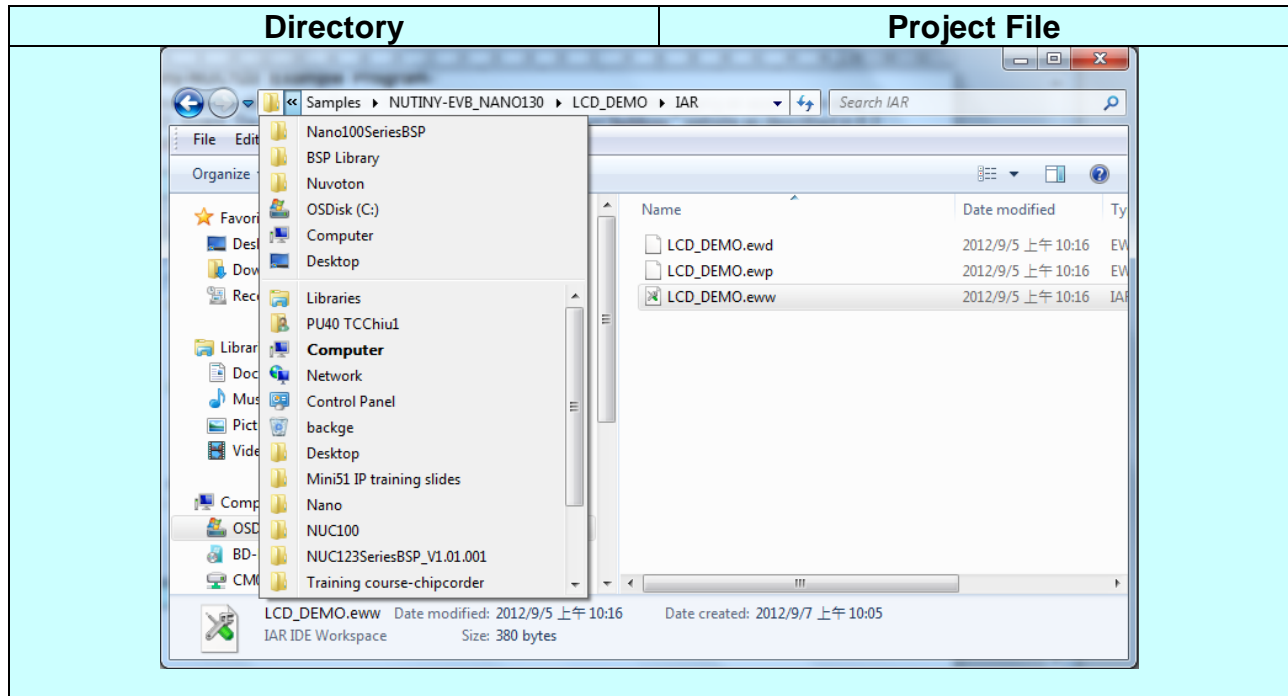







Figure 4-2 LCD_DEMO Example Directory

To use this example:

The LCD panel on the NuTiny-EVB-Nano130 board will display a NUVOTON logo.

-  **Start IAR Embedded Workbench**
- **File-Open-Workspace**
Open the LCD_DEMO.eww workspace file
-  **Project - Make**
Compile and link the LCD_DEMO application
-  **Project – Download and Debug**
Program the application code into on-chip Flash ROM
 - ◆  Single step through code
 - ◆  Reset the device
 - ◆  Run the application



5 NuTiny-EVB-Nano130 Schematics

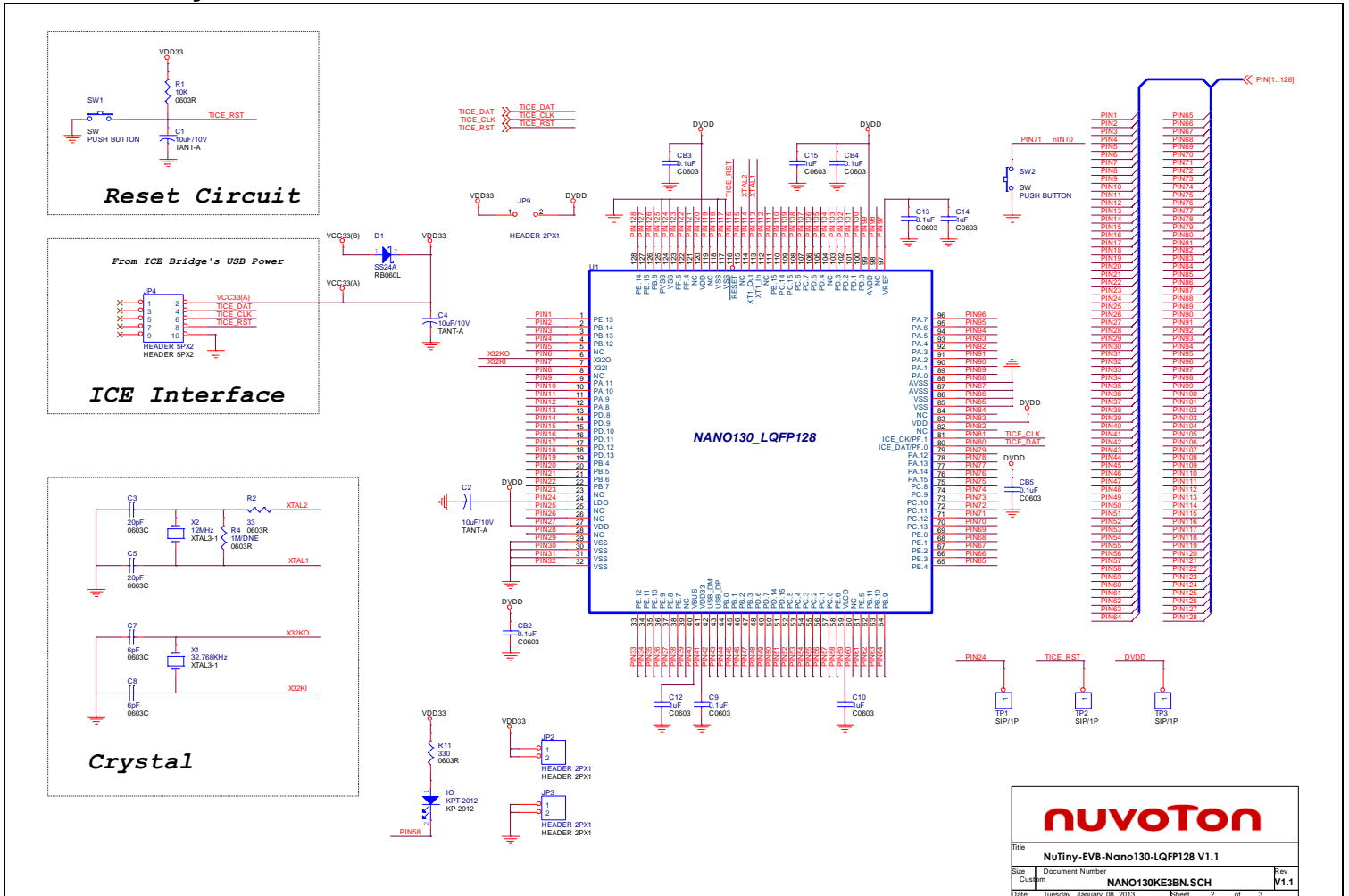

nuvoTon			
Title	NuTiny-EVB-Nano130-LQFP128 V1.1		
Size	Document Number	NANO130KE3BN.SCH	
Custom	Rev	V1.1	
Date	Tuesday, January 08, 2013	Page	2 of 3

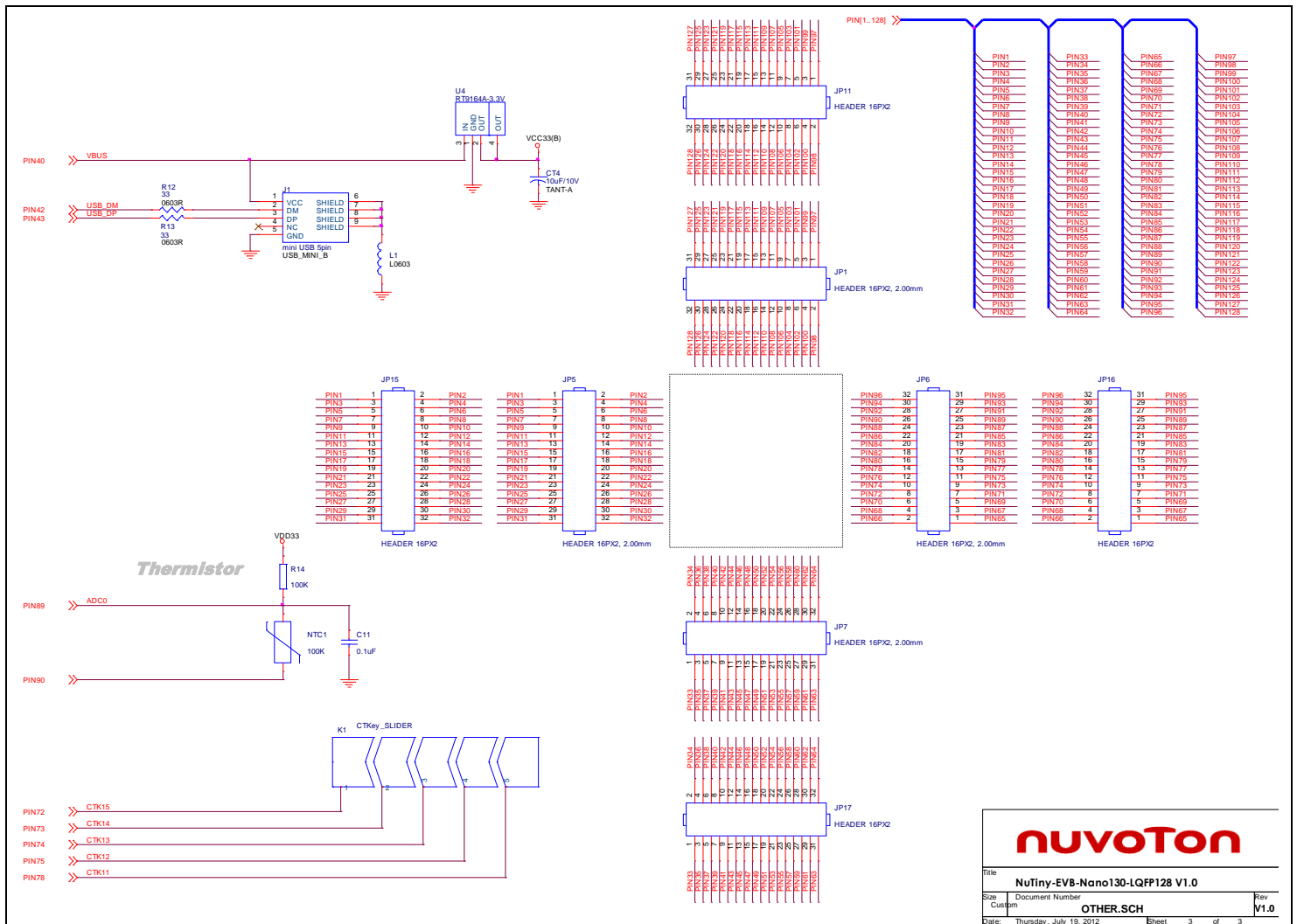

Title: **NuTiny-EVB-Nano130-LQFP128 V1.0**

Size: Document Number: **OTHER.SCH** Rev: **V1.0**

Date: Thursday, July 19, 2012 Sheet: 3 of 3

6 Downloading NuMicro™ Related Files from Nuvoton Website

6.1 Downloading NuMicro™ Keil μVision® IDE Driver

<p>Step 1</p>	<p>Visit the Nuvoton NuMicro™ website: http://www.nuvoton.com/NuMicro</p>
<p>Step 2</p>	 <p>The screenshot shows the Nuvoton website for the ARM Cortex™-M0 NuMicro® Family. The 'Development Resources' section is expanded, and the 'Device Driver and Software Library' link is highlighted with a red dashed box. A yellow callout bubble with a red arrow points to this link, containing the text: "Click here to enter Device Driver and Software Library."</p>

	M051 Series BSP_RegCtrlPrg_v1.00.001.zip NUC100 Series Driver Reference Guide	M051 series software package based on register programming coding rule for sample code & user guide.	V1.00.001 V1.03.001												
	NUC100 Series BSP_CMSIS_v1.03.002.zip NUC100 Series Driver Reference Guide (Simplified Chinese)	NUC100 series software package based on CMSIS version 1.3. It supports both IAR and Keil development environment with drivers and samples codes. Examples source code for NuTiny-100/120 and Learning Board are included. For detailed, please download it and unzip it.	V1.03.002 V1.03.001												
Step 3	<u>Programmer Software Tools Package</u>														
	<table border="1"> <thead> <tr> <th>File name</th> <th>Description</th> <th>Version</th> </tr> </thead> <tbody> <tr> <td> ICP Programming Tool (Build 4228) V1.03.zip</td> <td>NuMicro ICP tool & user manual</td> <td>V1.03</td> </tr> <tr> <td> ISP Programming Tool.zip</td> <td>NuMicro ISP Programming Tool & user manual</td> <td>V1.40</td> </tr> <tr> <td> NuGang Programmer V5.31.zip</td> <td>NuGang Programmer software & user manual</td> <td>V5.31</td> </tr> </tbody> </table>			File name	Description	Version	ICP Programming Tool (Build 4228) V1.03.zip	NuMicro ICP tool & user manual	V1.03	ISP Programming Tool.zip	NuMicro ISP Programming Tool & user manual	V1.40	NuGang Programmer V5.31.zip	NuGang Programmer software & user manual	V5.31
	File name	Description	Version												
	ICP Programming Tool (Build 4228) V1.03.zip	NuMicro ICP tool & user manual	V1.03												
	ISP Programming Tool.zip	NuMicro ISP Programming Tool & user manual	V1.40												
NuGang Programmer V5.31.zip	NuGang Programmer software & user manual	V5.31													
<u>Nu-Link Driver</u>															
<table border="1"> <thead> <tr> <th>File name</th> <th>Description</th> <th>Version</th> </tr> </thead> <tbody> <tr> <td> Nu-Link Driver for Keil RVMDK(Build 4228) V1.03.zip</td> <td>This driver is to support Nu-Link recognized by Keil RVMDK Development Environment and support all NuMicro Family Devices selectable.</td> <td>V1.03</td> </tr> <tr> <td> Nu-Link Driver for IAR EWARM(Build 4228) V1.03.zip</td> <td>This driver is to support Nu-Link recognized by IAR EWARM Development Environment and support all NuMicro Family Devices selectable.</td> <td>V1.03</td> </tr> </tbody> </table>			File name	Description	Version	Nu-Link Driver for Keil RVMDK(Build 4228) V1.03.zip	This driver is to support Nu-Link recognized by Keil RVMDK Development Environment and support all NuMicro Family Devices selectable.	V1.03	Nu-Link Driver for IAR EWARM(Build 4228) V1.03.zip	This driver is to support Nu-Link recognized by IAR EWARM Development Environment and support all NuMicro Family Devices selectable.	V1.03				
File name	Description	Version													
Nu-Link Driver for Keil RVMDK(Build 4228) V1.03.zip	This driver is to support Nu-Link recognized by Keil RVMDK Development Environment and support all NuMicro Family Devices selectable.	V1.03													
Nu-Link Driver for IAR EWARM(Build 4228) V1.03.zip	This driver is to support Nu-Link recognized by IAR EWARM Development Environment and support all NuMicro Family Devices selectable.	V1.03													
Contact us: NuMicro@nuvoton.com															
Step 4	Download the NuMicro Keil μ Vision [®] IDE driver.														

6.2 Downloading NuMicro™ IAR EWARM Driver

Step 1 Visit the Nuvoton NuMicro™ website: <http://www.nuvoton.com/NuMicro>

Step 2

The screenshot shows the Nuvoton website for the NuMicro family. The navigation bar includes links for About Nuvoton, Products & Sales, News & Events, Investor, Human Resources, Member Area, and Download Service. The main content area is titled 'ARM Cortex™-M0 NuMicro® Family' and features a product image of a 32-bit ARM Cortex-M0 MCU. Below the image, there are four columns of links: Products, Development Resources, Technical Support, and News and Events. A red arrow points from a yellow callout box to the 'Device Driver and Software Library' link in the Development Resources column.

Products

- MCU Products Brochure (English)
- MCU Products Brochure (Chinese)
- Online Products Selection
- Distributor Information

Development Resources

- Products Brief, DataSheet
- Technical Reference Manual
- Development Tools
 - Device Driver and Software Library
 - NuMicro Development Tools
 - Third Party Starter Kit
- Application Notes

Technical Support

- Quick Start
- Online Training
- Forum (Chinese version)
- FAQ

News and Events

- NuMicro® NEWS List
 - IAR KickStart Kit™ for NuMicro® Family 32-bit ARM® Cortex™-M0 MCU - 1/24/2011
- Events
 - Mar. 1, 2011 Nuvoton Technology to Display Powerful NuMicro® Family at Embedded World 2011 Exhibition & Conference in Germany

NuMicro® Family

M051 Base Line

Click here to enter Device Driver and Software Library.

Step 3	M051 Series BSP_RegCtrlPrg_v1.00.001.zip NUC100 Series Driver Reference Guide	M051 series software package based on register programming coding rule for sample code & user guide.	V1.00.001 V1.03.001												
	NUC100 Series BSP_CMSIS_v1.03.002.zip NUC100 Series Driver Reference Guide (Simplified Chinese)	NUC100 series software package based on CMSIS version 1.3. It supports both IAR and Keil development environment with drivers and samples codes. Examples source code for NuTiny-100/120 and Learning Board are included. For detailed, please download it and unzip it.	V1.03.002 V1.03.001												
	<p><u>Programmer Software Tools Package</u></p> <table border="1"> <thead> <tr> <th>File name</th> <th>Description</th> <th>Version</th> </tr> </thead> <tbody> <tr> <td> ICP Programming Tool (Build 4228) V1.03.zip</td> <td>NuMicro ICP tool & user manual</td> <td>V1.03</td> </tr> <tr> <td> ISP Programming Tool.zip</td> <td>NuMicro ISP Programming Tool & user manual</td> <td>V1.40</td> </tr> <tr> <td> NuGang Programmer V5.31.zip</td> <td>NuGang Programmer software & user manual</td> <td>V5.31</td> </tr> </tbody> </table>			File name	Description	Version	ICP Programming Tool (Build 4228) V1.03.zip	NuMicro ICP tool & user manual	V1.03	ISP Programming Tool.zip	NuMicro ISP Programming Tool & user manual	V1.40	NuGang Programmer V5.31.zip	NuGang Programmer software & user manual	V5.31
	File name	Description	Version												
ICP Programming Tool (Build 4228) V1.03.zip	NuMicro ICP tool & user manual	V1.03													
ISP Programming Tool.zip	NuMicro ISP Programming Tool & user manual	V1.40													
NuGang Programmer V5.31.zip	NuGang Programmer software & user manual	V5.31													
<p><u>Nu-Link Driver</u></p> <table border="1"> <thead> <tr> <th>File name</th> <th>Description</th> <th>Version</th> </tr> </thead> <tbody> <tr> <td> Nu-Link Driver for Keil RVMDK(Build 4228) V1.03.zip</td> <td>This driver is to support Nu-Link recognized by Keil RVMDK Development Environment and support all NuMicro Family Devices selectable.</td> <td>V1.03</td> </tr> <tr> <td> Nu-Link Driver for IAR EWARM(Build 4228) V1.03.zip</td> <td>This driver is to support Nu-Link recognized by IAR EWARM Development Environment and support all NuMicro Family Devices selectable.</td> <td>V1.03</td> </tr> </tbody> </table> <p>Contact us: NuMicro@nuvoton.com</p>			File name	Description	Version	Nu-Link Driver for Keil RVMDK(Build 4228) V1.03.zip	This driver is to support Nu-Link recognized by Keil RVMDK Development Environment and support all NuMicro Family Devices selectable.	V1.03	Nu-Link Driver for IAR EWARM(Build 4228) V1.03.zip	This driver is to support Nu-Link recognized by IAR EWARM Development Environment and support all NuMicro Family Devices selectable.	V1.03				
File name	Description	Version													
Nu-Link Driver for Keil RVMDK(Build 4228) V1.03.zip	This driver is to support Nu-Link recognized by Keil RVMDK Development Environment and support all NuMicro Family Devices selectable.	V1.03													
Nu-Link Driver for IAR EWARM(Build 4228) V1.03.zip	This driver is to support Nu-Link recognized by IAR EWARM Development Environment and support all NuMicro Family Devices selectable.	V1.03													
Step 4	Download the NuMicro™ IAR Embedded Workbench® driver.														

6.3 Downloading NuMicro™ Nano100 series BSP Software Library

Step 1	Visit the Nuvoton NuMicro™ website: http://www.nuvoton.com/NuMicro
Step 2	<p>The screenshot shows the Nuvoton NuMicro website. The 'Development Resources' section is highlighted with a red dashed box, and a red arrow points from a yellow callout bubble to the 'Device Driver and Software Library' link. The callout bubble contains the text: 'Click here to enter Device Driver and Software Library.'</p>
Step 3	Download the NuMicro™ Nano100 series software library.



7 Revision History

Revision	Date	Description
1.00	Oct. 16, 2012	Preliminary version
1.01	Jan. 8, 2013	Changed the value of C7 and C8 in the schematics from 10pF to 6 pF

Important Notice

Nuvoton products are not designed, intended, authorized or warranted for use as components in systems or equipment intended for surgical implantation, atomic energy control instruments, airplane or spaceship instruments, transportation instruments, traffic signal instruments, combustion control instruments, or for other applications intended to support or sustain life. Further more, Nuvoton products are not intended for applications wherein failure of Nuvoton products could result or lead to a situation wherein personal injury, death or severe property or environmental damage could occur.

Nuvoton customers using or selling these products for use in such applications do so at their own risk and agree to fully indemnify Nuvoton for any damages resulting from such improper use or sales.

Please note that all data and specifications are subject to change without notice. All the trademarks of products and companies mentioned in this datasheet belong to their respective owners.