

LED NUMERIC DISPLAY, 1 DIGIT
BL-S80X-11XX
Features:

- Ø 20.4mm (0.8") Single digit numeric display series, BI-COLOR TYPE
- Ø Low current operation.
- Ø Excellent character appearance.
- Ø Easy mounting on P.C. Boards or sockets.
- Ø I.C. Compatible.
- Ø ROHS Compliance.

Electrical-optical characteristics: (Ta=25°C) (Test Condition: IF=20mA)

Part No		Chip			VF Unit:V		Iv TYP.(mcd)
Common Cathode	Common Anode	Emitted Color	Material	λ_p (nm)	Typ	Max	
BL-S80A-11SG-XX	BL-S80B-11SG-XX	Super Red	AlGaInP	660	2.10	2.50	50
		Green	GaP/GaP	570	2.20	2.50	65
BL-S80A-11EG-XX	BL-S80B-11EG-XX	Orange	GaAsP/GaP	635	2.10	2.50	65
		Green	GaP/GaP	570	2.20	2.50	65
BL-S80A-11DUG-XX	BL-S80B-11DUG-XX	Ultra Red	AlGaInP	660	2.10	2.50	75
		Ultra Green	AlGaInP	574	2.20	2.50	75
BL-S80A-11UEUG-X X	BL-S80B-11UEUG-X X	Ultra Orange	AlGaInP	630	2.10	2.50	70
		Ultra Green	AlGaInP	574	2.20	2.50	75

-XX: Surface / Lens color :

Number	0	1	2	3	4	5
Ref Surface Color	White	Black	Gray	Red	Green	
Epoxy Color	Water clear	White diffused	Red Diffused	Green Diffused	Yellow Diffused	

Absolute maximum ratings (Ta=25°C)

Parameter	S	G	E	D	UG	UE		Unit
Forward Current I_F	30	30	30	30	30	30		mA
Power Dissipation P_d	75	80	80	75	75	65		mW
Reverse Voltage V_R	5	5	5	5	5	5		V
Peak Forward Current I_{PF} (Duty 1/10 @1KHZ)	150	150	150	150	150	150		mA
Operation Temperature T_{OPR}	-40 to +80							°C
Storage Temperature T_{STG}	-40 to +85							°C
Lead Soldering Temperature T_{SOL}	Max.260±5°C for 3 sec Max. (1.6mm from the base of the epoxy bulb)							°C

LED NUMERIC DISPLAY, 1 DIGIT

BL-S80X-11XX

Package configuration & Internal circuit diagram

BL-S80X-11 Series

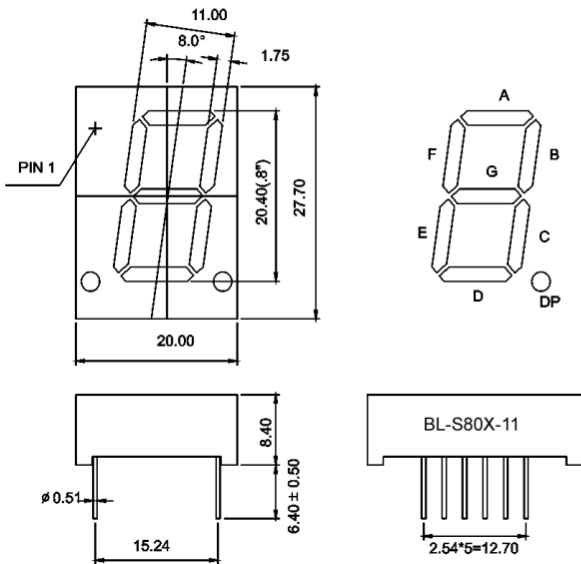

BL-S80A-11xx

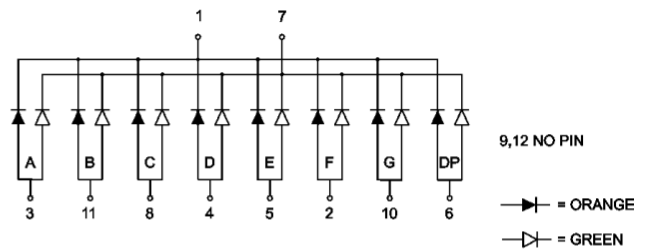

BL-S80B-11xx

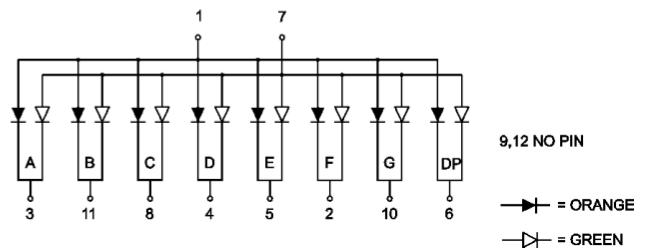

Notes:

1. All dimensions are in millimeters (inches)
2. Tolerance is $\pm 0.25(0.01)$ unless otherwise noted.
3. Specifications are subject to change without notice.

LED NUMERIC DISPLAY, 1 DIGIT

BL-S80X-11 XX

Typical electrical-optical characteristics curves:

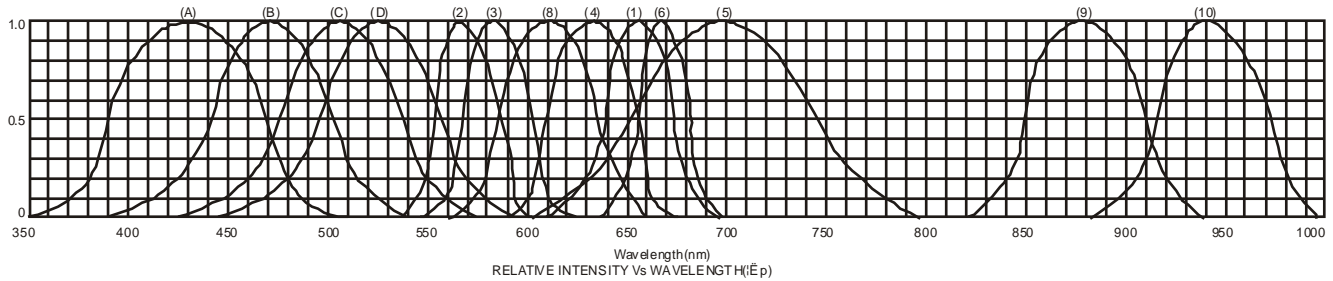

- (1) - GaAsP/GaAs 655nm/Red
- (2) - GaP 570nm/Yellow Green
- (3) - GaAsP/GaP 585nm/Yellow
- (4) - GaAsP/GaP 635nm/Orange & Hi-Eff Red
- (5) - GaP 700nm/Bright Red
- (6) - GaAlAs/GaAs 660nm/Super Red
- (8) - GaAsP/GaP 610nm/Super Red
- (9) - GaAlAs 880nm
- (10) - GaAs/GaAs & GaAlAs/GaAs 940nm
- (A) - GaN/SiC 430nm/Blue
- (B) - InGaN/SiC 470nm/Blue
- (C) - InGaN/SiC 505nm/Ultra Green
- (D) - InGaAlSiC 525nm/Ultra Green

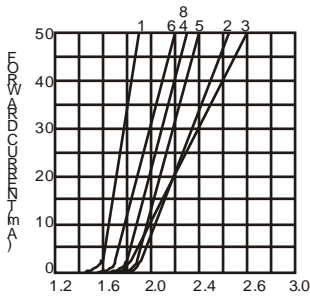

FORWARD VOLTAGE (Vf)
FORWARD CURRENT VS.
FORWARD VOLTAGE

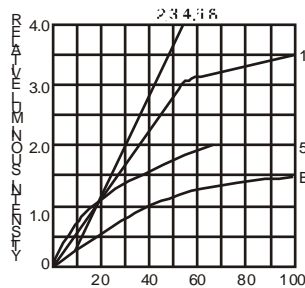

FORWARD CURRENT (mA)
RELATIVE LUMINOUS
INTENSITY VS. FORWARD
CURRENT

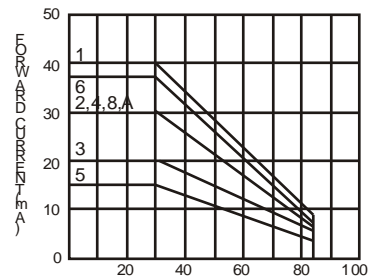

AMBIENT TEMPERATURE Ta ()
FORWARD CURRENT VS. AMBIENT
TEMPERATURE



AMBIENT TEMPERATURE Ta ()

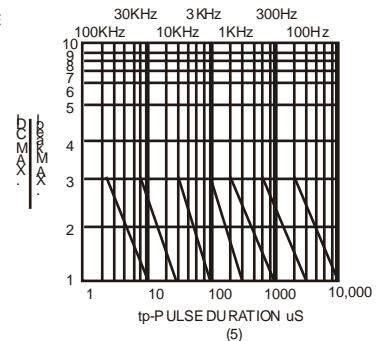
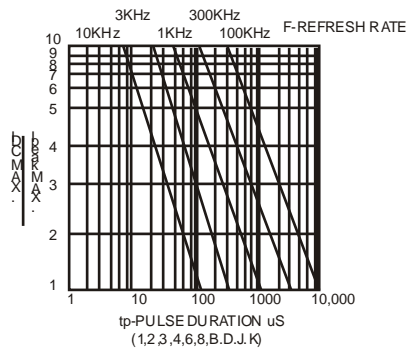

NOTE:25 free air temperature unless otherwise specified