

Round Type, Bi-color LED lamp

BL-L817

Features:

- 8.0mm Round Type BI-COLOR LED Lamps, with 2 leads
- Ultra brightness.
- Choice of various viewing angles.
- Diffused, Transparent and Water clear lens are available.
- IC compatible /Low current capability.
- RoHs Compliance



■ Electrical-optical characteristics: (Ta=25°C) (Test Condition: IF=20mA)

Part Number	Chip			Lens Type	Forward Voltage(VF) Unit:V		Luminous Intensity (Iv) Unit:mcd		Viewing Angle 2θ1/2(deg)
	Emitted Color	Material	λp (nm)		Typ	Max	Min.	Typ	
					Orange	GaAsP/GaP	635	2.10	
BL-L817EGW	Green	GaP/GaP	570	Water Diff.	2.20	2.50	5	12	60
	Yellow	GaAsP/GaP	585		2.10	2.50	5	12	
BL-L817YGW	Green	GaP/GaP	570		2.20	2.50	5	12	
	Ultra Yellow	AlGaInP	630		2.10	2.50	80	100	
BL-L817UEUGW	Ultra Green	AlGaInP	574		2.20	2.50	60	80	

■ Absolute maximum ratings (Ta=25°C)

Parameter	E	UE	Y	G	UG	Unit
Forward Current I _F	25	30	25	30	30	mA
Power Dissipation P _d	60	65	60	65	75	mW
Reverse Voltage V _R	5	5	5	5	5	V
Peak Forward Current I _{PF} (Duty 1/10 @1KHZ)	150	150	150	150	150	mA
Operation Temperature T _{OPR}	-40 to +80					°C
Storage Temperature T _{STG}	-40 to +85					°C
Lead Soldering Temperature T _{SOL}	Max.260±5°C for 3 sec Max. (1.6mm from the base of the epoxy bulb)					°C

Round Type, Bi-color LED lamp

BL-L817

■ Package configuration & Internal circuit diagram

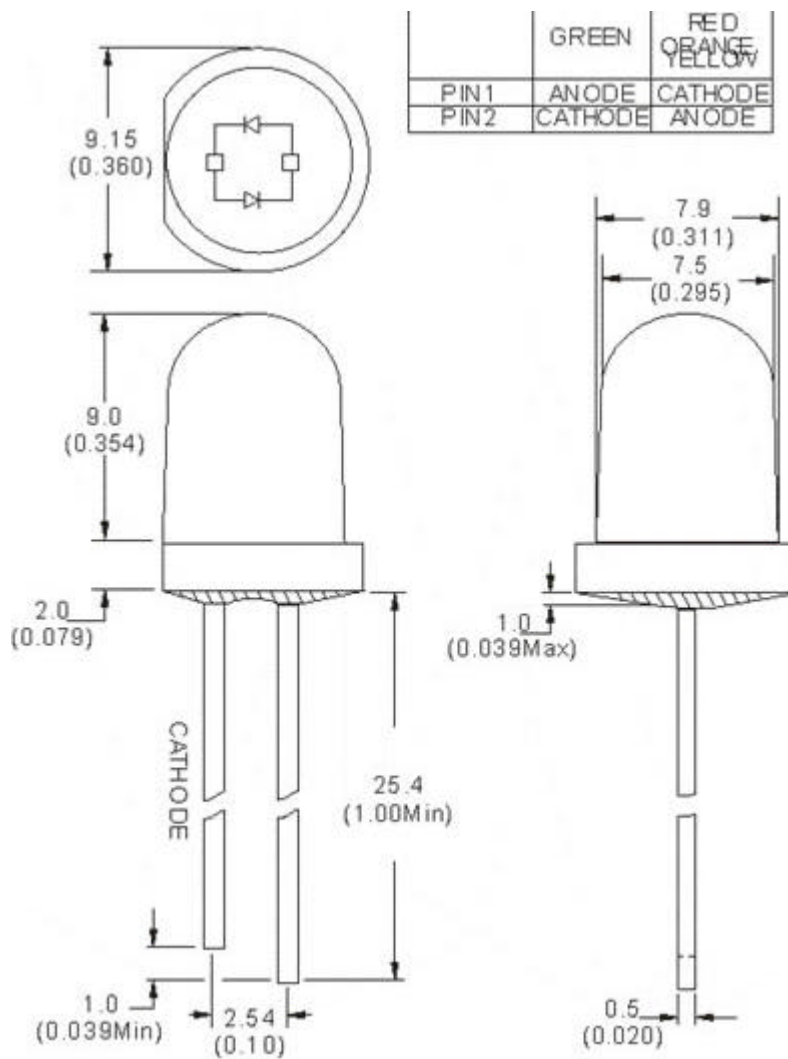

Notes:

1. All dimensions are in millimeters (inches)
2. Tolerance is $\pm 0.25(0.01)$ unless otherwise noted.
3. Specifications are subject to change without notice.

Round Type, Bi-color LED lamp

BL-L817

Typical electrical-optical characteristics curves:

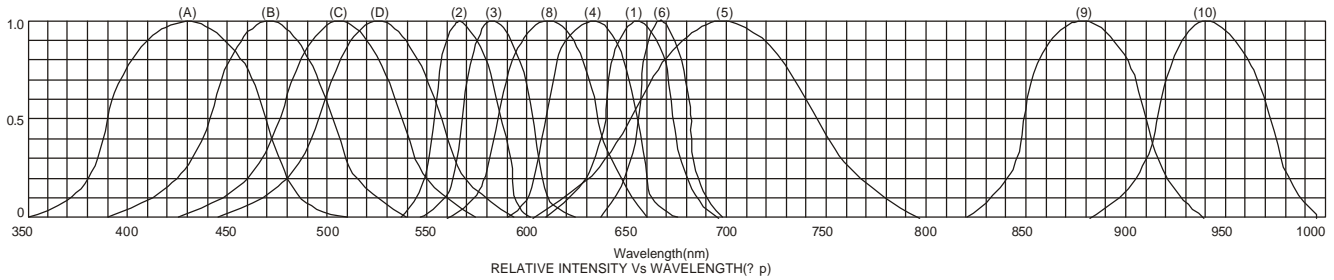

- (1) - GaAsP/GaAs 655nm/Red
- (2) - GaP 570nm/Yellow Green
- (3) - GaAsP/GaP 585nm/Yellow
- (4) - GaAsP/GaP 635nm/Orange & Hi-Eff Red
- (5) - GaP 700nm/Bright Red
- (6) - GaAlAs/GaAs 660nm/Super Red
- (8) - GaAsP/GaP 610nm/Super Red
- (9) - GaAlAs 880nm
- (10) - GaAs/GaAs & GaAlAs/GaAs 940nm
- (A) - GaN/SiC 430nm/Blue
- (B) - InGaN/SiC 470nm/Blue
- (C) - InGaN/SiC 505nm/Ultra Green
- (D) - InGaAl/SiC 525nm/Ultra Green

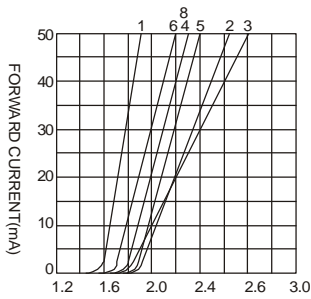

FORWARD VOLTAGE (Vf)
FORWARD CURRENT VS.
FORWARD VOLTAGE

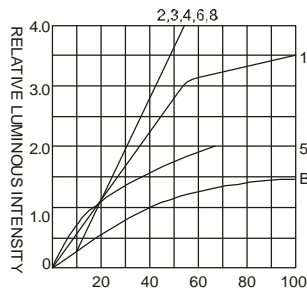

FORWARD CURRENT (mA)
RELATIVE LUMINOUS
INTENSITY VS. FORWARD
CURRENT

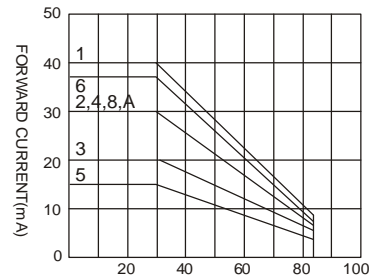

AMBIENT TEMPERATURE Ta()
FORWARD CURRENT VS. AMBIENT
TEMPERATURE

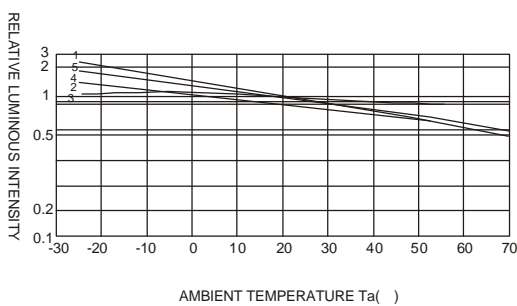

AMBIENT TEMPERATURE Ta()

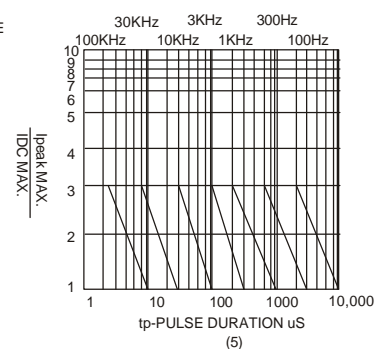
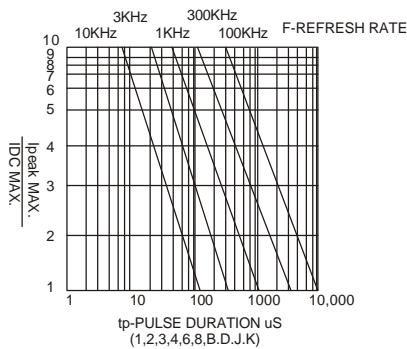

NOTE:25 free air temperature unless otherwise specified

Round Type, Bi-color LED lamp

BL-L817

■ Packing and weighting

