

THIS IS A C.A.D. GENERATED DRAWING
DO NOT MAKE MANUAL REVISIONS TO MASTER.

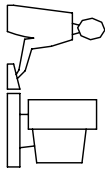

* UNLESS OTHERWISE SPECIFIED TOLERANCES
ON DECIMAL IS: ANGLE ± 1°
.XX ± 0.35
UNIT: MM

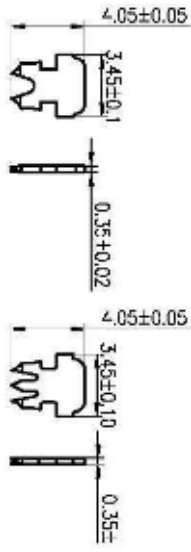
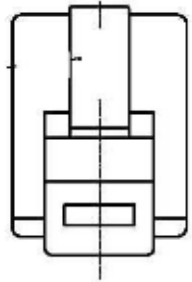
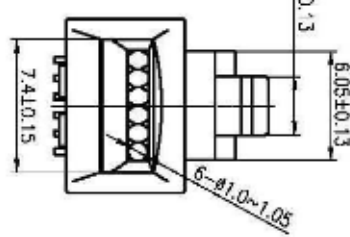
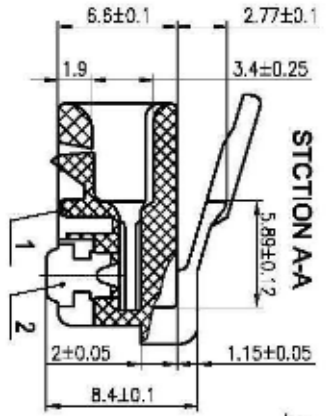
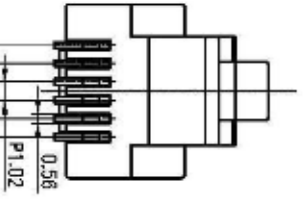
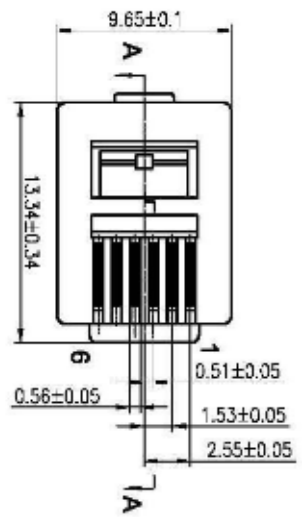

Electrical:
Contact current rating: 1.5AMPS
Dielectric withstanding voltage: 500VAC
Insulation resistance: 1000 MegOhms Min.
Contact resistance: 30 MilliOhms Max
Operating temperature: -55 °C to +85 °C

Materials:
Contacts: Copper alloy
Insulator: Thermoplastic PA9T UL 94V-0
Shell: Steel
Gold plating: 50 microinch

THESE DRAWINGS AND SPECIFICATIONS ARE THE PROPERTY OF MH CONNECTORS LTD. AND SHALL NOT BE REPRODUCED, COPIED OR USED AS THE BASIS FOR THE MANUFACTURE OR SALE OF APPARATUS WITHOUT WRITTEN PERMISSION.

DRAWN	DATE	
JDHNNY	08-20-12	
APPROVED	DATE	
SCALE	SHEET OF	REV:
1:1	1 OF 1	A
DRAWING No		
MHRJ126P6CR		



THIS SERIES FULLY CONFORMS TO THE
EUROPEAN UNION DIRECTIVES 2002/95/EC
AND 2002/96/EC FOR ROHS COMPLIANCY.



MH CONNECTORS LTD.