

LED NUMERIC DISPLAY, 1 DIGIT
BL-S56X-15
Features:

- Ø 14.20mm (0.56") Single digit numeric display series.
- Ø Low current operation.
- Ø Excellent character appearance.
- Ø Easy mounting on P.C. Boards or sockets.
- Ø I.C. Compatible.
- Ø ROHS Compliance.

RoHS Compliance
Super Bright
Electrical-optical characteristics: (Ta=25°C) (Test Condition: IF=20mA)

Part No		Chip			VF Unit:V		Iv
Common Cathode	Common Anode	Emitted Color	Material	λ_p (nm)	Typ	Max	TYP.(mcd)
BL-S56A-15S-XX	BL-S56B-15S-XX	Hi Red	GaAlAs/GaAs,SH	660	1.85	2.20	30
BL-S56A-15D-XX	BL-S56B-15D-XX	Super Red	GaAlAs/GaAs,DH	660	1.85	2.20	45
BL-S56A-15UR-XX	BL-S56B-15UR-XX	Ultra Red	GaAlAs/GaAs,DDH	660	1.85	2.20	50
BL-S56A-15E-XX	BL-S56B-15E-XX	Orange	GaAsP/GaP	635	2.10	2.50	35
BL-S56A-15Y-XX	BL-S56B-15Y-XX	Yellow	GaAsP/GaP	585	2.10	2.50	35
BL-S56A-15G-XX	BL-S56B-15G-XX	Green	GaP/GaP	570	2.20	2.50	35

Ultra Bright
Electrical-optical characteristics: (Ta=25°C) (Test Condition: IF=20mA)

Part No		Chip			VF Unit:V		Iv
Common Cathode	Common Anode	Emitted Color	Material	λ_p (nm)	Typ	Max	TYP.(mcd)
BL-S56A-15UHR-XX	BL-S56B-15UHR-XX	Ultra Red	AlGaInP	645	2.10	2.50	50
BL-S56A-15UE-XX	BL-S56B-15UE-XX	Ultra Orange	AlGaInP	630	2.10	2.50	38
BL-S56A-15YO-XX	BL-S56B-15YO-XX	Ultra Amber	AlGaInP	619	2.10	2.50	38
BL-S56A-15UY-XX	BL-S56B-15UY-XX	Ultra Yellow	AlGaInP	590	2.10	2.50	38
BL-S56A-15UG-XX	BL-S56B-15UG-XX	Ultra Green	AlGaInP	574	2.20	2.50	45
BL-S56A-15PG-XX	BL-S56B-15PG-XX	Ultra Pure Green	InGaN	525	3.80	4.50	60
BL-S56A-15B-XX	BL-S56B-15B-XX	Ultra Blue	InGaN	470	2.70	4.20	58
BL-S56A-15W-XX	BL-S56B-15W-XX	Ultra White	InGaN	/	2.70	4.20	65

-XX: Surface / Lens color :

Number	0	1	2	3	4	5
Ref Surface Color	White	Black	Gray	Red	Green	
Epoxy Color	Water clear	White diffused	Red Diffused	Green Diffused	Yellow Diffused	

LED NUMERIC DISPLAY, 1 DIGIT
BL-S56X-15
Absolute maximum ratings (Ta=25°C)

Parameter	S	D	UR	E	Y	G	Unit
Forward Current I_F	25	25	25	25	25	30	mA
Power Dissipation P_d	60	60	60	60	60	65	mW
Reverse Voltage V_R	5	5	5	5	5	5	V
Peak Forward Current I_{PF} (Duty 1/10 @1KHZ)	150	150	150	150	150	150	mA
Operation Temperature T_{OPR}	-40 to +80						°C
Storage Temperature T_{STG}	-40 to +85						°C
Lead Soldering Temperature T_{SOL}	Max.260±5°C for 3 sec Max. (1.6mm from the base of the epoxy bulb)						°C

Absolute maximum ratings (Ta=25°C)

Parameter	UHR	UE	YO	UY	UG	PG	UB	UW	Unit
Forward Current I_F	30	30	30	30	30	30	30	30	mA
Power Dissipation P_d	75	65	65	65	75	110	120	120	mW
Reverse Voltage V_R	5	5	5	5	5	5	5	5	V
Peak Forward Current I_{PF} (Duty 1/10 @1KHZ)	150	150	150	150	150	150	100	100	mA
Operation Temperature T_{OPR}	-40 to +80								°C
Storage Temperature T_{STG}	-40 to +85								°C
Lead Soldering Temperature T_{SOL}	Max.260±5°C for 3 sec Max. (1.6mm from the base of the epoxy bulb)								°C

LED NUMERIC DISPLAY, 1 DIGIT

BL-S56X-15

Package configuration & Internal circuit diagram

BL-S56X-15 Series

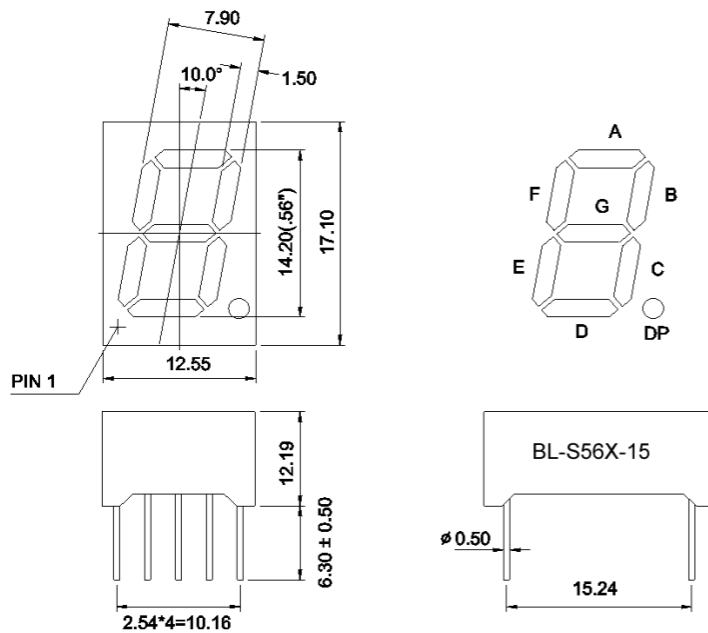

BL-S56A-15

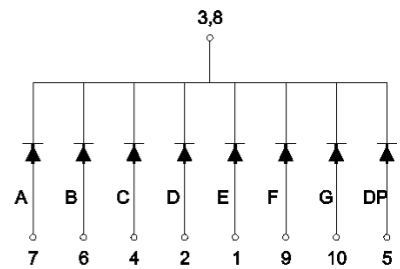

BL-S56B-15

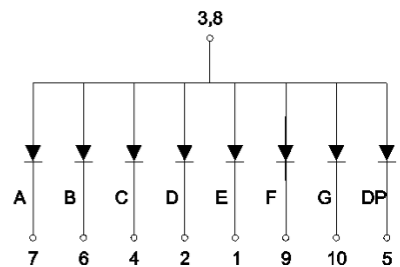

Notes:

1. All dimensions are in millimeters (inches)
2. Tolerance is $\pm 0.25(0.01)$ unless otherwise noted.
3. Specifications are subject to change without notice.

LED NUMERIC DISPLAY, 1 DIGIT

BL-S56X-15

Typical electrical-optical characteristics curves:

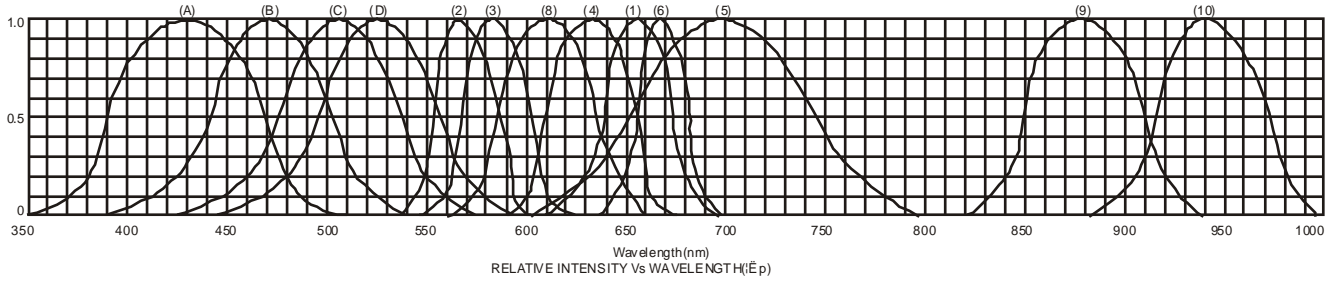

- (1) - GaAsP/GaAs 655nm/Red
- (2) - GaP 570nm/Yellow Green
- (3) - GaAsP/GaP 585nm/Yellow
- (4) - GaAsP/GaP 635nm/Orange & Hi-Eff Red
- (5) - GaP 700nm/Bright Red
- (6) - GaAlAs/GaAs 660nm/Super Red
- (8) - GaAsP/GaP 610nm/Super Red
- (9) - GaAlAs 880nm
- (10) - GaAs/GaAs & GaAlAs/GaAs 940nm
- (A) - GaN/SiC 430nm/Blue
- (B) - InGaN/SiC 470nm/Blue
- (C) - InGaN/SiC 505nm/Ultra Green
- (D) - InGaAlSiC 525nm/Ultra Green

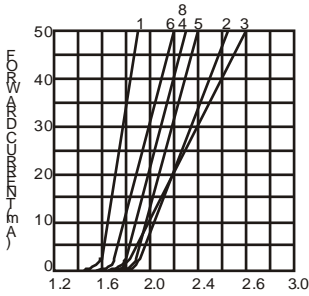

FORWARD VOLTAGE (Vf)
FORWARD CURRENT VS.
FORWARD VOLTAGE

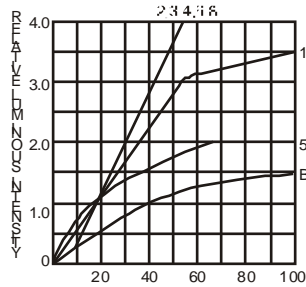

FORWARD CURRENT (mA)
RELATIVE LUMINOUS
INTENSITY VS. FORWARD
CURRENT

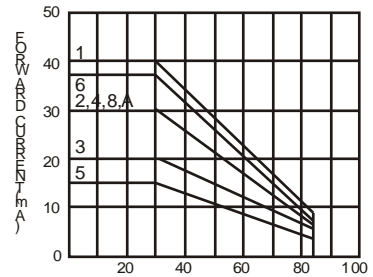

AMBIENT TEMPERATURE Ta ()
FORWARD CURRENT VS. AMBIENT
TEMPERATURE

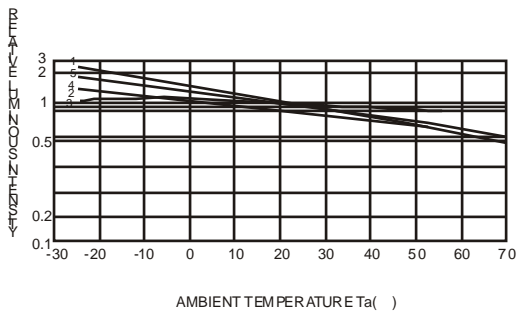

AMBIENT TEMPERATURE Ta ()

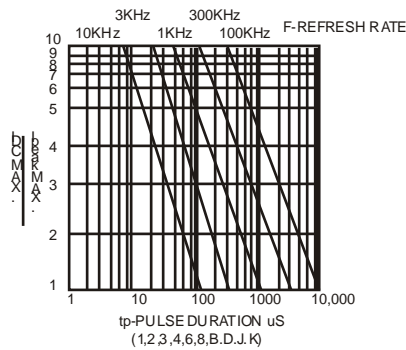

tp-PULSE DURATION µs
(1,2,3,4,6,8,B,D,J,K)

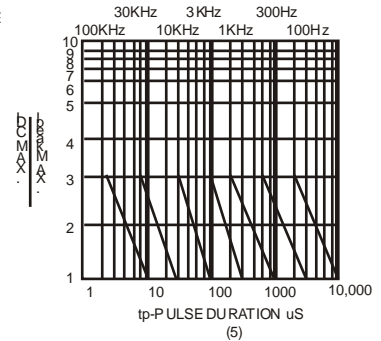

(5)

NOTE:25 free air temperature unless otherwise specified