

Round Type LED lamp
BL-L312
Features:

- Ø 3mm Round Type LED Lamps.
- Ø Ultra brightness.
- Ø Choice of various viewing angles.
- Ø Diffused, Transparent and Water clear lens
- Ø IC compatible /Low current capability.
- Ø RoHs Compliance

RoHs Compliance
Electrical-optical characteristics: (Ta=25°C) (Test Condition: IF=20mA)

Part Number	Chip			Lens Type	Forward Voltage(VF) Unit:V		Luminous Intensity (Iv) Unit:mcd		Viewing Angle 2θ/2 (deg)
	Emitted Color	Material	λp (nm)		Typ	Max	Min.	Typ.	
					Water Clear				
BL-L312SRC	Hi Red	AlGaAs,SH	660		1.85	2.20	50	220	30
BL-L312LRC	Super Red	AlGaAs,DH	660		1.85	2.20	200	500	
BL-L312URC	Ultra Red	AlGaAs,DDH	660		1.95	2.20	500	900	
BL-L312UEC	Ultra Orange	AlGaInP	630		2.10	2.50	900	1800	
BL-L312UYC	Ultra Yellow	AlGaInP	590		2.10	2.50	900	2000	
BL-L312UGC	Ultra Green	AlGaInP	574		2.20	2.50	220	600	
BL-L312PGC	Ultra Pure Green	InGaN	525		3.80	4.50	1200	3000	
BL-L312BGC	Ultra Bluish Green	InGaN	505		3.80	4.50	900	2800	
BL-L312BC	Blue	InGaN	430		3.80	4.50	400	900	
BL-L312UBC	Ultra Blue	InGaN	470		2.70	4.20	500	1400	
BL-L312VC	UV	InGaN	405		3.80	4.50	100	150	
BL-L312UWC	Ultra White	InGaN	/		2.70	4.20	900	2000	

Absolute maximum ratings (Ta=25°C)

Parameter	SR	LR	UR	UE	UY	UG	PG	BG	B	UB	UV	W	Unit
Forward Current I _F	25	25	25	30	30	30	30	30	30	30	30	30	mA
Power Dissipation P _d	60	60	60	65	65	75	110	110	120	120	120	120	mW
Reverse Voltage V _R	5	5	5	5	5	5	5	5	5	5	5	5	V
Peak Forward Current I _{PF} (Duty 1/10 @1KHZ)	150	150	150	150	150	150	150	100	100	100	100	100	mA
Operation Temperature T _{OPR}	-40 to +80												°C
Storage Temperature T _{STG}	-40 to +85												°C
Lead Soldering Temperature TSOL	Max.260±5°C for 3 sec Max. (1.6mm from the base of the epoxy bulb)												°C

Round Type LED lamp

BL-L312

Package configuration & Internal circuit diagram

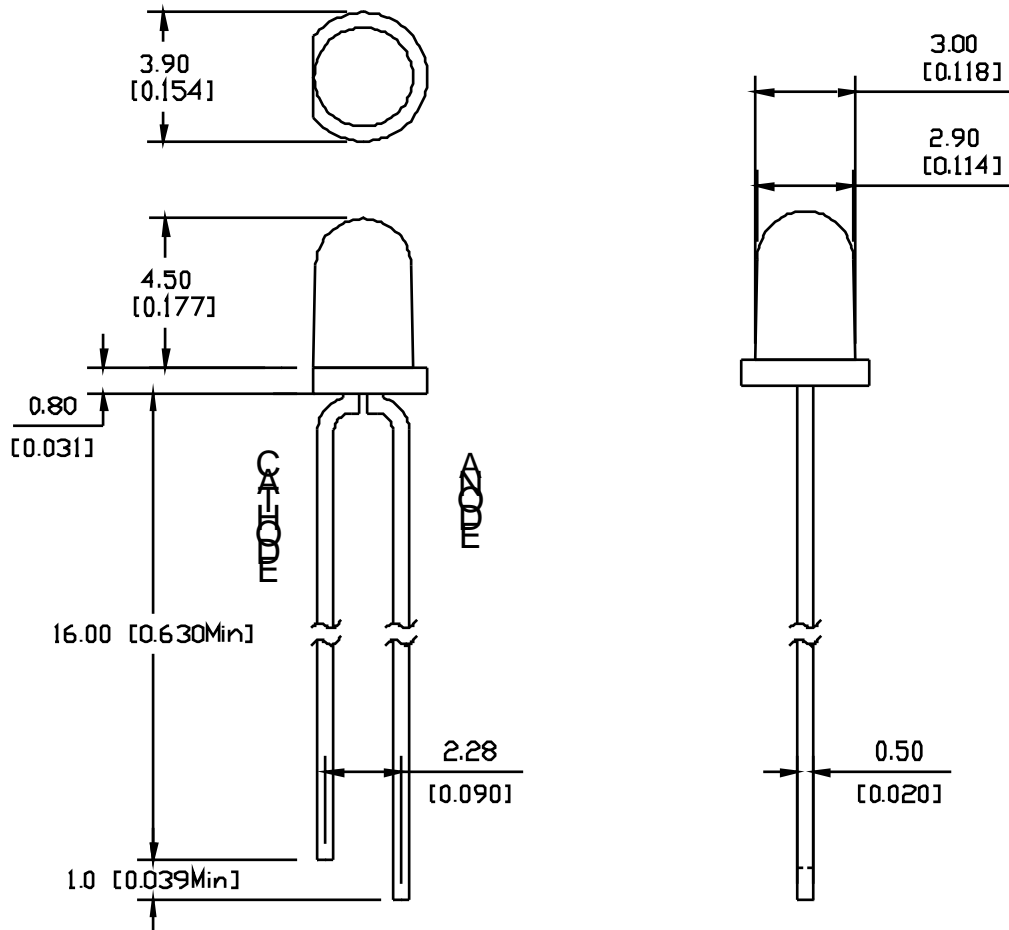

Notes:

1. All dimensions are in millimeters (inches)
2. Tolerance is $\pm 0.25(0.01)$ unless otherwise noted.
3. Specifications are subject to change without notice.

Round Type LED lamp

BL-L312

Typical electrical-optical characteristics curves:

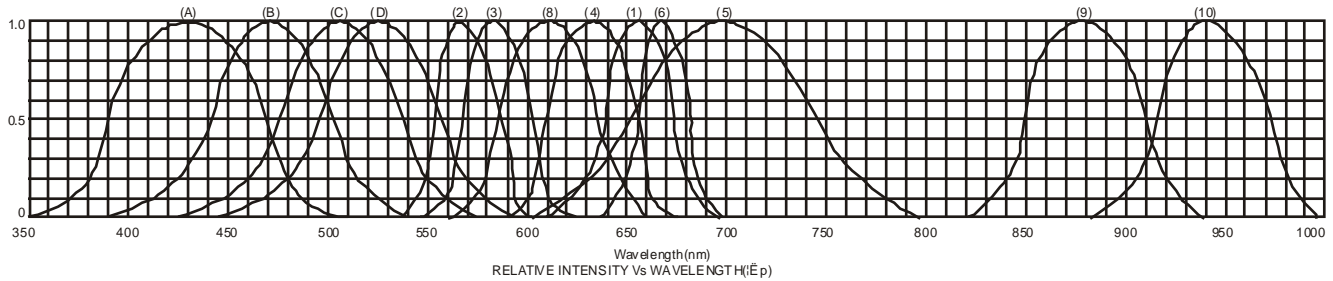

- | | |
|---|--------------------------------------|
| (1) - GaAsP/GaAs 655nm/Red | (9) - GaAlAs 880nm |
| (2) - GaP 570nm/Yellow Green | (10) - GaAs/GaAs & GaAlAs/GaAs 940nm |
| (3) - GaAsP/GaP 585nm/Yellow | (A) - GaN/SiC 430nm/Blue |
| (4) - GaAsP/GaP 635nm/Orange & Hi-Eff Red | (B) - InGaN/SiC 470nm/Blue |
| (5) - GaP 700nm/Bright Red | (C) - InGaN/SiC 505nm/Ultra Green |
| (6) - GaAlAs/GaAs 660nm/Super Red | (D) - InGaAlSiC 525nm/Ultra Green |
| (8) - GaAsP/GaP 610nm/Super Red | |

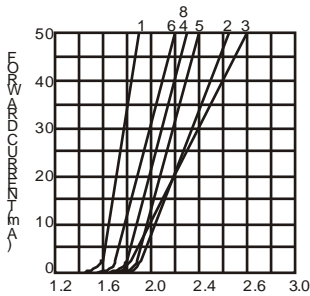

FORWARD VOLTAGE (Vf)
FORWARD CURRENT VS.
FORWARD VOLTAGE

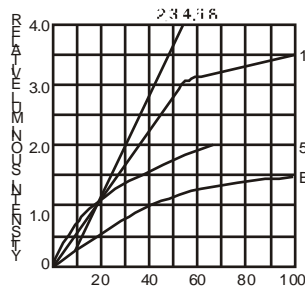

FORWARD CURRENT (mA)
RELATIVE LUMINOUS
INTENSITY VS. FORWARD
CURRENT

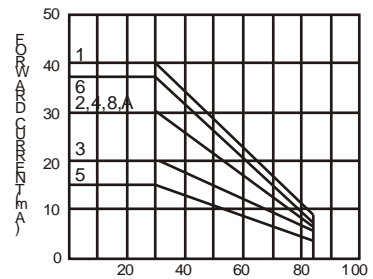

AMBIENT TEMPERATURE Ta (°C)
FORWARD CURRENT VS. AMBIENT
TEMPERATURE



AMBIENT TEMPERATURE Ta (°C)

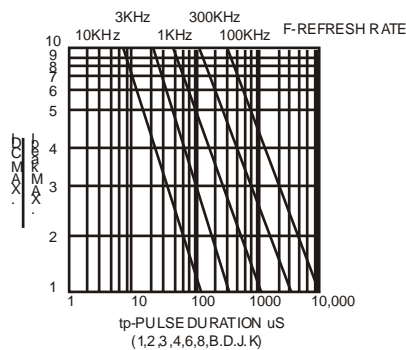

tp-PULSE DURATION μ S
(1,2,3,4,6,8,B,D,J,K)

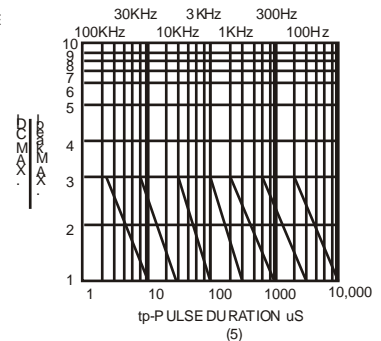

tp-PULSE DURATION μ S
(5)

NOTE: 25 °C free air temperature unless otherwise specified